

# Help Center

## Quick Start

Getting started with your DEBUT devices now

## User Essentials

Understanding the fundamentals about DEBUT devices and Ecotopia data platform

## INTELINK

Introduction and user guide for BLE-based INTELINK technology

## Data Platform

User guide for Ecotopia Data Center and App

## FAQ

Possible issues that may occur when using DEBUT devices or Ecotopia data platform and the relevant solutions

## Troubleshooting

Instructions to troubleshoot abnormal conditions with devices or data platforms

## SwiftTips Video

Video tutorials for device usage tips and setting guidance

## What's New

Latest features of Ecotopia Data Center and Ecotopia App

## Version History

Version history of Ecotopia Data Center  
and Ecotopia App

# DEBUT Series Quick Start (Cellular)

This guide is for series devices that transmit data through cellular (2G/3G/4G/5G) network. The models include FLEX, FLEX II, LEGO, MINI, OMNI, and BADGE, etc.

---

## System Architecture

The flow-chart below shows how data is transmitted from such device to your account.

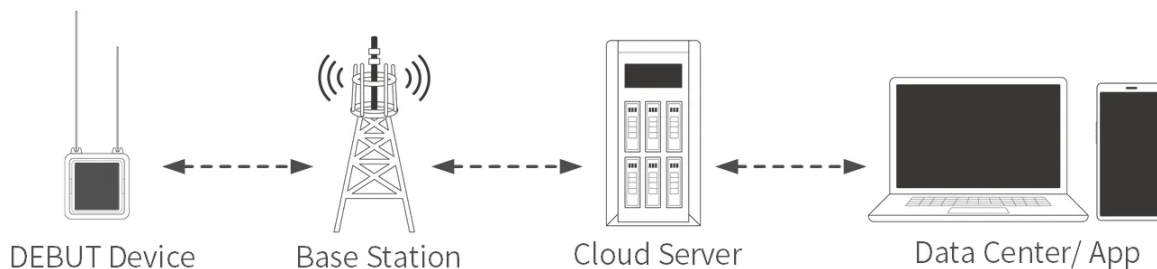

## Before Using

Make sure you have an Ecotopia account to log in to Ecotopia App and data center.

- Ecotopia App: Search "Ecotopia" on App Store or Google Play. This is the App icon: 
- Ecotopia data center: <https://www.ecotopiago.com/>

You can operate all devices under the account after logging in.

Before test, please [switch the data subscription status](#) from the default "Suspended" to "Active" and subscribe additional data including [ODBA data](#) if you need.

---

# Getting Started

## Step 1: Charge the device (rechargeable devices only)

Place the device under direct sunlight for several hours or longer, depending on the weather.

Note: Avoid placing the device directly on concrete floor, rock or metal surface, especially in summer, because fast rising temperature of such surface (sometimes could be over 80°C) could cause permanent damage to the device. When deployed on animal, however, the device temperature is influenced by animal body temperature and will not be too high.

## Step 2: Turn on the device and deliver settings

We recommend that you always turn on a device with your mobile phone connected to network, especially for the first time of device initialization.

Note: If you plan to initialize your device in an environment without mobile network, please make sure you have cached all necessary information in your mobile phone beforehand. For details, see [Cache management](#).

1. Authorize Bluetooth to Ecotopia App, and log in with your account.
2. Tap INTELINK icon  on App and wait for 15~ 20 seconds. You will see a list of devices. Those in blue color are detected by App.
3. Tap to select one device, or tap and hold to select multiple devices. Follow the instructions to turn them on, and deliver the settings to the device. Note:
  - For some batches of devices, shake a device to see LED blinking (blinking LED light indicates that INTELINK of the device has been activated), then tap INTELINK icon and turn on the device before the LED blinking stops.
  - "Setting delivery" is an important step to initialize your device. By doing this, the device can obtain the fine settings that are suitable for each sub-model. When your App is connected to network, it will obtain the correct settings from the cloud server. Without network connection, the App will use the information you cached in your mobile phone.

## Step 3: View the data

Place the device in open space with a sky view, and keep it far from high walls, metal surface, strong magnet, or liquid surface (like wet floor). This provides a favorable environment for GPS signal receiving and gateway connection.

The device will start to collect and transmit data, according to its settings. Then you can check the data on Ecotopia App and data center.

Before deployment, it is highly suggested to keep the device working for several days. During the period, you can get familiar with the system, get to know the best device setting for local environment and be sure the battery is fully charged before deployment.

We will give you in-time technical support during testing and deployment to ensure the device can work at its best performance.

### **Alternative Method for Turning-On**

Some models can also be turned on/off by magnet. If you have already initialized your devices, you can also use magnet for turning on. The method is described below:

Place the magnetic switch close to the blue dot as shown below for at least 5 seconds. The green LED light blinks for 3 seconds and goes out, and the device is turned on.



Debut FLEX

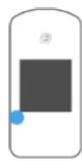

Debut FLEX II



Debut LEGO

However, this method might not give you accurate feedback. For example, the LED blinking pattern might not be obvious in daylight, and the App does not have an updated record about device on/off status and battery level. So, unless you are very familiar with DEBUT devices, we suggest you to always use App for turning on.

Another thing to note is that when you use magnet to turn off devices, all data stored on board will be erased, as well as the fine settings. So, if you turned off a device with magnet, you should initialize it again with App before you deploy it on animals.

---

## **Data Service Fee Management**

Data service fee consumption of a device in each month is determined by its data subscription status during that month. To optimize the data service fees for your devices, it is important to manage their data subscription status based on your needs.

In addition, please keep your account balance positive to avoid disruptions to data services. To recharge your data service fee, please contact your sales representative for assistance.

For more information, see [Ecotopia Data Service Fee](#).

---

## SATISFACTION GUARANTEE

Druid Technology offers triple satisfaction guarantee to relieve you from any worries.

### 6-Month Return & Refund (customized products not included)

You can apply for return & refund within 6 months since the date of purchase if you are not satisfied with the device. You will cover data service fee incurred in the period.

Limitations: The device hasn't been deployed, altered or tampered with and should be without any cosmetic damages. It should function properly as remotely tested and confirmed by Druid.

### 1-Year Limited Warranty

Your device enjoys 1-year limited warranty since the date of purchase. During the period, Druid will repair or replace, depending on the actual case and technical feasibility, any defective devices. You need to return the device to Druid for service.

Limitations: Warranty does not apply to defects resulting from improper maintenance or use<sup>[1]</sup>, physical damage, or operation outside environmental specifications.

### DEBUT Renewal Plan (Optional)

Apart from return & refund and limited warranty, you can purchase DEBUT Renewal Plan as a lifetime insurance that offers you a new device without condition. You can also purchase renewal plan for the replaced new device. After the service is used, the status of old device will turn to **Terminated**.

<sup>[1]</sup>Improper maintenance or use may cause permanent damage and affect warranty. Please read the following cautions carefully:

- Keep the surrounding environment temperature of the device under 60°C in any circumstances. Otherwise, permanent damage may happen to the device;
- Keep the device away from magnetic field or electric field (for example, a transformer);
- Take proper protection measures to prevent the device from falling on hard surfaces;
- Don't dismantle, alter or tamper with the device.
- Be sure to charge the battery periodically
  - at least 1 day every 2 weeks for models like ULTRA and NANO P1 lite
  - every 4 weeks for models like NANO/MINI/INTERREX/FLEX II
  - every 8~12 weeks for models like FLEX II Argos/FLEX II MAX/LEGO

After that, turn on the device, synchronize data and turn it off for storage. During the process, no need to change data subscription status. This is important to battery maintenance and can affect warranty.

When you dispose your device and/or other batteries, make sure that it is done sustainably.

# DEBUT Series Quick Start (Satellite)

This guide is for DEBUT series devices that transmit data via satellites communication. The models include but not limited to MINI Argos, FLEX Argos, TAG Argos, BADGE Iridium, BADGE BD, YACHT, etc.

## System Architecture

The flow-chart below shows how data is transmitted from such device to your account (MINI Argos is used as an example).

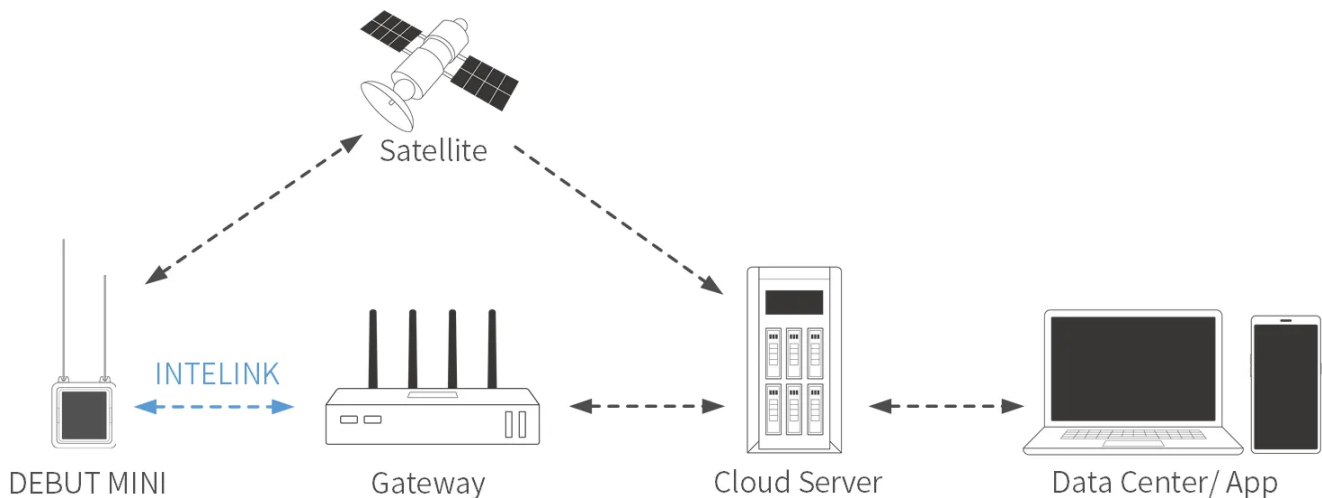

## Before Using

Make sure you have an Ecotopia account to log in to Ecotopia App and data center.

- Ecotopia App: Search "Ecotopia" on App Store or Google Play. This is the App icon: 
- Ecotopia data center: <https://www.ecotopiago.com/>



You can operate all devices under the account after logging in.

Before test, please [switch the data subscription status](#) from the default "Suspended" to "Active" and subscribe additional data including [ODBA data](#) if you need.

---

## Getting Started

### Step 1: Charge the device (rechargeable devices only)

Place the device under direct sunlight for several hours or longer, depending on the weather.

Note: Avoid placing the device directly on concrete floor, rock or metal surface, especially in summer, because fast rising temperature of such surface (sometimes could be over 80°C) could cause permanent damage to the device. When deployed on animal, however, the device temperature is influenced by animal body temperature and will not be too high.

### Step 2: Turn on the device and deliver settings

We recommend that you always turn on a device with your mobile phone connected to network, especially for the first time of device initialization.

Note: If you plan to initialize your device in an environment without mobile network, please make sure you have cached all necessary information in your mobile phone beforehand. For details, see [Cache management](#).

1. Authorize Bluetooth to Ecotopia App, and log in with your account.
2. Tap INTELINK icon  on App and wait for 15~ 20 seconds. You will see a list of devices. Those in blue color are detected by App.
3. Tap to select one device, or tap and hold to select multiple devices. Follow the instructions to turn them on, and deliver the settings to the device.

Note:

- For some batches of devices, shake a device to see LED blinking (blinking LED light indicates that INTELINK of the device has been activated), then tap INTELINK icon and turn on the device before the LED blinking stops.

- "Setting delivery" is an important step to initialize your device. By doing this, the device can obtain the fine settings that are suitable for each sub-model. When your App is connected to network, it will obtain the correct settings from the cloud server. Without network connection, the App will use the information you cached in your mobile phone.

### Step 3: View the data

Place the device in open space with a sky view, and keep it far from high walls, metal surface, strong magnet, or liquid surface (like wet floor). This provides a favorable environment for GPS signal receiving and gateway connection.

The device will collect data and transmit data to satellites. Then you can check the data on Ecotopia App and data center.

Note: Be noted that the device offers more than other way for you to obtain data from the device. Please check [Data synchronization](#). Data downloaded in this way will be displayed in the GPS data, Environment data, and Behavior Data columns, not the Argos/Iridium/Beidou Data column.

Before deployment, it is highly suggested to keep the device working for several days. During the period, you can get familiar with the system, get to know the best device setting for local environment and be sure the battery is fully charged before deployment.

We will give you in-time technical support during testing and deployment to ensure the device can work at its best performance.

---

## Advanced Settings of Argos-GPS Device

Classic Argos PTTs provide global doppler locations, of which the accuracy varies between several hundred meters to several kilometers. GPS locations enjoy much better accuracy.

Different from Doppler method, GPS collects location data independently, meaning that the GPS data schedule is not related to Argos transmission.

To better under the device functions, we need to bear in mind some features of the Argos system:

1. Argos transmission capacity is limited. When a device enjoys sufficient power supply (big battery or good solar charging), it is able to collect hundred pieces of GPS data per day, which is overwhelming for Argos transmission.

2. Argos transmission relies on satellite pass, and satellite pass timing varies with latitude. The higher the latitude, the longer the satellite pass periods, thus the more chance for data reception. This means the devices for migrating species should not use a fixed Argos transmission schedule.
3. Argos satellite reception can be notably affected by weather (e.g., thick cloud could lead to more transmission failures). This means the Argos transmission can fail even during satellite pass period.
4. Argos satellite will not tell the device whether a piece of data is successfully received or not.

Given the above ground, DEBUT series Argos-GPS devices are designed with a scheme described below for researchers to maximum the valid data reception without jeopardizing the device energy balance.

1. The device is able to use its latest GPS locations to predict Argos satellite pass. When the timing arrives, the device will make continuous transmissions to the satellites.
2. The device has an advanced setting called “GPS data queue” which is to help you get more evenly distributed GPS data.

For example, you set the device to collect GPS every hour, while at your latitude, the Argos satellite pass happens during 1:10 pm ~ 2:50 pm and 9:00 pm ~ 11:00 pm. And you set the GPS data queue to “8”.

In this situation, when the first satellite pass happens at 1:10pm, the latest 8 pieces of GPS data, which collected at 6:00 am, 7:00 am, 8:00 am, 9:00 am, 10:00 am, 11:00 am, 12:00 am, 1:00 pm, will enter the transmission queue. The device will attempt to transmit the GPS data, one at a time and repeatedly, to the Argos satellites.

Such data queue setting makes sure that the data collected during the blank period (when there's no satellite pass at all) can also have chances to be received.

With appropriate settings and good solar charging conditions, we have seen a lot of our Argos devices uploading over 40 valid GPS points per day at 38° latitude.

---

## Data Service Fee Management

Data service fee consumption of a device in each month is determined by its data subscription status during that month. To optimize the data service fees for your devices, it is important to

manage their data subscription status based on your needs.

In addition, please keep your account balance positive to avoid disruptions to data services. To recharge your data service fee, please contact your sales representative for assistance.

For more information, see [Ecotopia Data Service Fee](#).

---

## **SATISFACTION GUARANTEE**

Druid Technology offers triple satisfaction guarantee to relieve you from any worries.

### **6-Month Return & Refund (customized products not included)**

You can apply for return & refund within 6 months since the date of purchase if you are not satisfied with the device. You will cover data service fee incurred in the period.

Limitations: The device hasn't been deployed, altered or tampered with and should be without any cosmetic damages. It should function properly as remotely tested and confirmed by Druid.

### **1-Year Limited Warranty**

Your device enjoys 1-year limited warranty since the date of purchase. During the period, Druid will repair or replace, depending on the actual case and technical feasibility, any defective devices. You need to return the device to Druid for service.

Limitations: Warranty does not apply to defects resulting from improper maintenance or use<sup>[1]</sup>, physical damage, or operation outside environmental specifications.

### **DEBUT Renewal Plan (Optional)**

Apart from return & refund and limited warranty, you can purchase DEBUT Renewal Plan as a lifetime insurance that offers you a new device without condition. You can also purchase renewal plan for the replaced new device. After the service is used, the status of old device will turn to **Terminated**.

<sup>[1]</sup>Improper maintenance or use may cause permanent damage and affect warranty. Please read the following cautions carefully:

- Keep the surrounding environment temperature of the device under 60°C in any circumstances. Otherwise, permanent damage may happen to the device;
- Keep the device away from magnetic field or electric field (for example, a transformer);
- Take proper protection measures to prevent the device from falling on hard surfaces;
- Don't dismantle, alter or tamper with the device.
- Be sure to charge the battery periodically
  - at least 1 day every 2 weeks for models like ULTRA and NANO P1 lite
  - every 4 weeks for models like NANO/MINI/INTERREX/FLEX II
  - every 8~12 weeks for models like FLEX II Argos/FLEX II MAX/LEGO

After that, turn on the device, synchronize data and turn it off for storage. During the process, no need to change data subscription status. This is important to battery maintenance and can affect warranty.

When you dispose your device and/or other batteries, make sure that it is done sustainably.

# DEBUT Series Quick Start (INTELINK)

This guide is for DEBUT series devices that transmit data with INTELINK technologies. The models include NANO, ULTRA, YAWL, MINI LoRa, and BADGE LoRa, etc.

---

## System Architecture

The flow-chart below shows how data is transmitted from such device to your account.

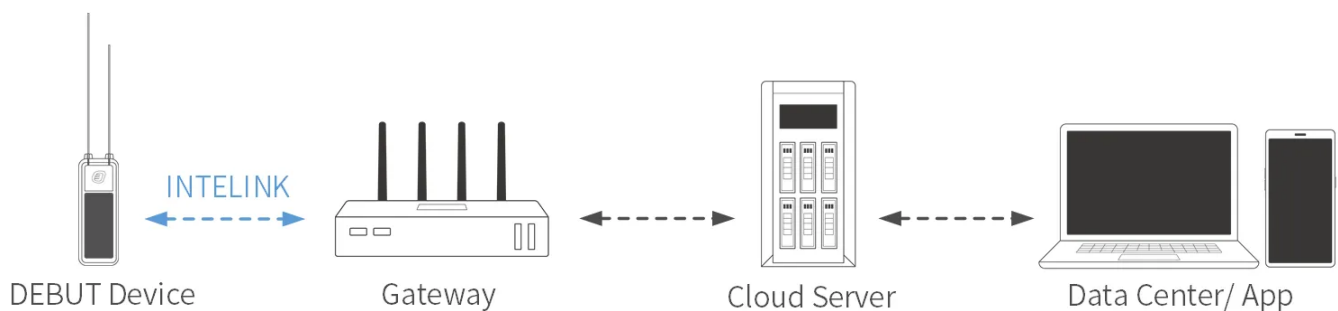

## Before Using

Make sure you have an Ecotopia account to log in to Ecotopia App and data center.

- Ecotopia App: Search "Ecotopia" on App Store or Google Play. This is the App icon: 
- Ecotopia data center: <https://www.ecotopiago.com/>

You can operate all devices under the account after logging in.

Before test, please [switch the data subscription status](#) from the default "Suspended" to "Active" and subscribe additional data including [ODBA data](#) if you need.

---

# Getting Started

## Step 1: Charge the device (rechargeable devices only)

Place the device under direct sunlight for several hours or longer, depending on the weather.

Note: Avoid placing the device directly on concrete floor, rock or metal surface, especially in summer, because fast rising temperature of such surface (sometimes could be over 80°C) could cause permanent damage to the device. When deployed on animal, however, the device temperature is influenced by animal body temperature and will not be too high.

## Step 2: Turn on the device and deliver settings

We recommend that you always turn on a device with your mobile phone connected to network, especially for the first time of device initialization.

Note: If you plan to initialize your device in an environment without mobile network, please make sure you have cached all necessary information in your mobile phone beforehand. For details, see [Cache management](#).

1. Authorize Bluetooth to Ecotopia App, and log in with your account.
2. Tap INTELINK icon  on App and wait for 15~ 20 seconds. You will see a list of devices. Those in blue color are detected by App.
3. Tap to select one device, or tap and hold to select multiple devices. Follow the instructions to turn them on, and deliver the settings to the device. Note:
  - For some batches of devices, shake a device to see LED blinking (blinking LED light indicates that INTELINK of the device has been activated), then tap INTELINK icon and turn on the device before the LED blinking stops.
  - "Setting delivery" is an important step to initialize your device. By doing this, the device can obtain the fine settings that are suitable for each sub-model. When your App is connected to network, it will obtain the correct settings from the cloud server. Without network connection, the App will use the information you cached in your mobile phone.

## Step 3: Obtain and View the data

Place the device in open space with a sky view, and keep it far from high walls, metal surface, strong magnet, or liquid surface (like wet floor). This provides a favorable environment for GPS signal receiving and gateway connection.

The device will start collecting data. After a few hours, use INTELINK function on Ecotopia App to search for the device again, and choose “Data synchronization”. The data will be automatically uploaded to cloud server via network connection of your mobile phone. Then, you can view the data on App and data center.

Before deployment, it is highly suggested to keep the device working for several days. During the period, you can get familiar with the system, get to know the best device setting for local environment and be sure the battery is fully charged before deployment.

We will give you in-time technical support during testing and deployment to ensure the device can work at its best performance.

---

## About Gateway

Gateway is a device that is able to collect data from DEBUT series devices via INTELINK and then send the data to cloud server via network connection. During the above process, your mobile phone is functioning as the most common gateway when you download data with Ecotopia App.

If you want a professional gateway that can be placed in the field, automatically collecting data from a long distance, delivering new settings to the tags, and recording how the tagged animals enter and exit its communication zone, as well as many other advanced functions, please contact [support@druid.tech](mailto:support@druid.tech).

---

## Data Service Fee Management

Data service fee consumption of a device in each month is determined by its data subscription status during that month. To optimize the data service fees for your devices, it is important to manage their data subscription status based on your needs.

In addition, please keep your account balance positive to avoid disruptions to data services. To recharge your data service fee, please contact your sales representative for assistance.

For more information, see [Ecotopia Data Service Fee](#).



---

## SATISFACTION GUARANTEE

Druid Technology offers triple satisfaction guarantee to relieve you from any worries.

### 6-Month Return & Refund (customized products not included)

You can apply for return & refund within 6 months since the date of purchase if you are not satisfied with the device. You will cover data service fee incurred in the period.

Limitations: The device hasn't been deployed, altered or tampered with and should be without any cosmetic damages. It should function properly as remotely tested and confirmed by Druid.

### 1-Year Limited Warranty

Your device enjoys 1-year limited warranty since the date of purchase. During the period, Druid will repair or replace, depending on the actual case and technical feasibility, any defective devices. You need to return the device to Druid for service.

Limitations: Warranty does not apply to defects resulting from improper maintenance or use<sup>[1]</sup>, physical damage, or operation outside environmental specifications.

### DEBUT Renewal Plan (Optional)

Apart from return & refund and limited warranty, you can purchase DEBUT Renewal Plan as a lifetime insurance that offers you a new device without condition. You can also purchase renewal plan for the replaced new device. After the service is used, the status of old device will turn to **Terminated**.

<sup>[1]</sup>Improper maintenance or use may cause permanent damage and affect warranty. Please read the following cautions carefully:

- Keep the surrounding environment temperature of the device under 60°C in any circumstances. Otherwise, permanent damage may happen to the device;
- Keep the device away from magnetic field or electric field (for example, a transformer);
- Take proper protection measures to prevent the device from falling on hard surfaces;

- Don't dismantle, alter or tamper with the device.
- Be sure to charge the battery periodically
  - at least 1 day every 2 weeks for models like ULTRA and NANO P1 lite
  - every 4 weeks for models like NANO/MINI/INTERREX/FLEX II
  - every 8~12 weeks for models like FLEX II Argos/FLEX II MAX/LEGO

After that, turn on the device, synchronize data and turn it off for storage. During the process, no need to change data subscription status. This is important to battery maintenance and can affect warranty.

When you dispose your device and/or other batteries, make sure that it is done sustainably.

# DEBUT Series Quick Start (HUB)

DEBUT HUB is a powerful device normally used as a network gateway. With GNSS, network communication modules, multiple sensors, flexible power-supply sources, and Druid's patented INTELINK technology, it is usually used in the wild field to provide network communication for other DEBUT devices, monitor colony entry/exit behaviors, and search for lost devices.

This guide also applies to TAG G which is of the same function as HUB, unless otherwise specified.

---

## System Architecture

The flow-chart below shows how data is transmitted from such device to your account.

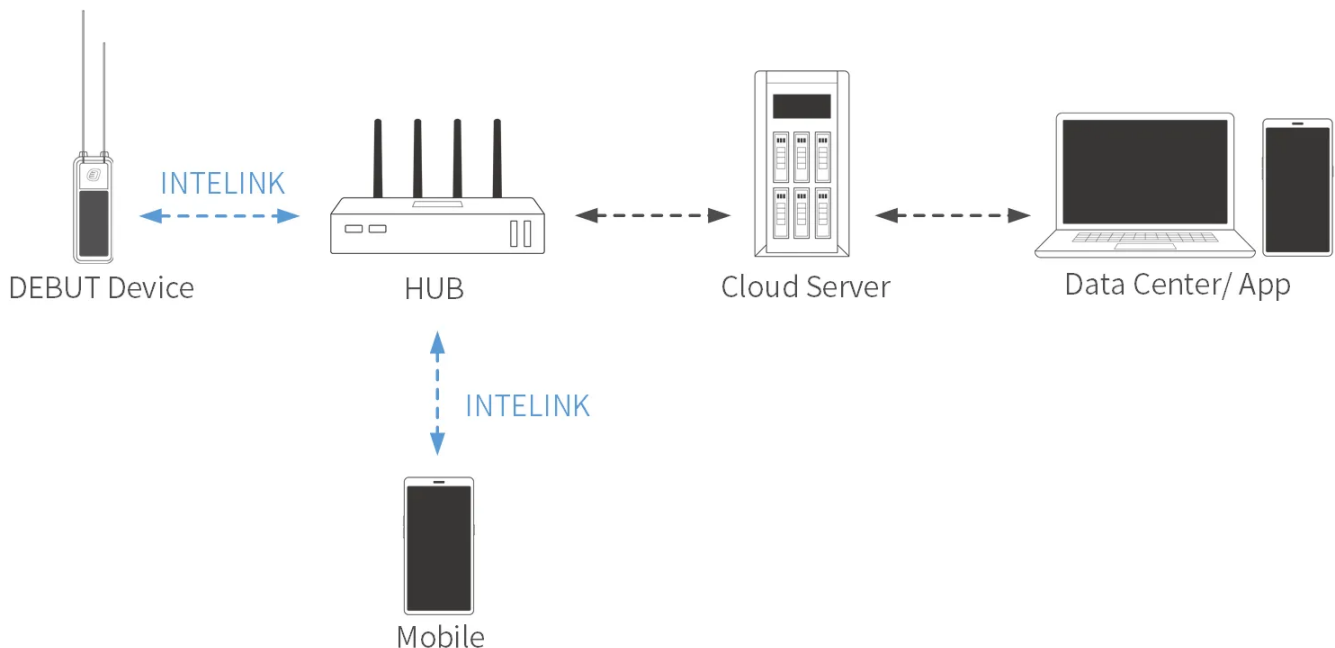

## Before Using

Make sure you have an Ecotopia account to log in to Ecotopia App and data center.

- Ecotopia App: Search "Ecotopia" on App Store or Google Play. This is the App icon: 
- Ecotopia data center: <https://www.ecotopiago.com/>

You can operate all devices under the account after logging in.

Before test, please [switch the data subscription status](#) from the default "Suspended" to "Active" and subscribe additional data including [ODBA data](#) if you need.

---

## Getting Started

### Step 1: Assign Devices to HUB

Log in to Ecotopia data center, and click **Device** > **Gateway** from the left sidebar menu.

Here you will see your gateway device list including HUB. Click  icon on the right side of the list to enter terminal device list page. Then click  to choose the devices to assign to HUB.

Note:

- To protect privacy, HUB can only communicate with devices assigned to it.
- You can assign one device to multiple HUBs.

### Step 2: Install Antennas for HUB

Install the three antennas for HUB as shown below.

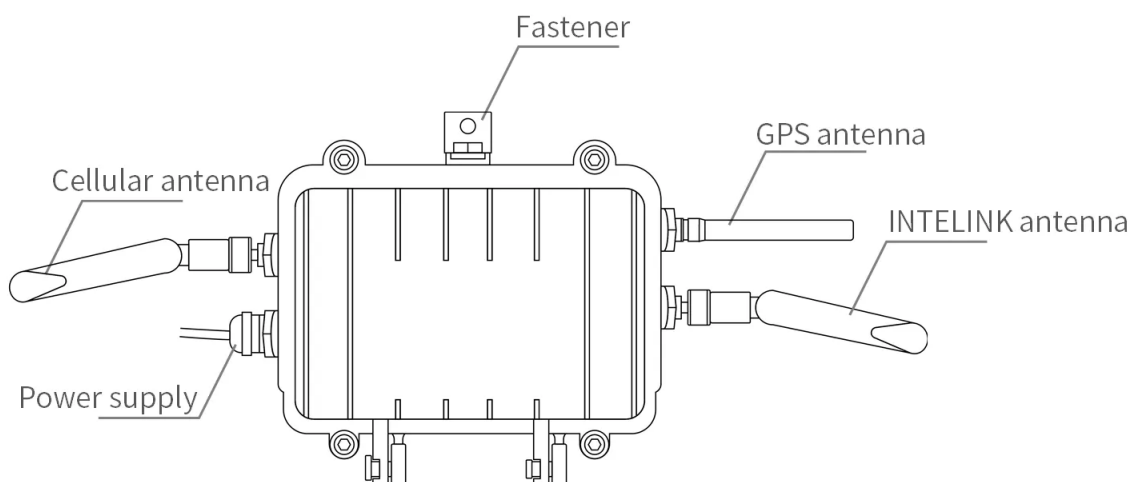

You can determine the type of antenna based on the silkscreen markings at the base of the antenna (note that the markings may vary due to different production batches).

- Cellular antenna: The base of the antenna is marked with the communication standards supported by the gateway, such as "2G/3G/4G/NB" and so on.
- GPS antenna: The base of the antenna is marked with "GPS".
- INTELINK antenna: The base of the antenna is marked with "INTELINK (BLE)" or "TX2400-JKD-20", etc.

Note: Installing antenna is not needed for TAG G.

### Step 3: Turn On HUB and Deliver Settings

It is recommended that you always turn on a device with your mobile phone connected to network, especially for the first time of device initialization.

Note: If you plan to initialize your device in an environment without mobile network, please make sure you have cached all necessary information in your mobile phone beforehand. For details, see [Cache management](#).

1. Authorize Bluetooth to Ecotopia App, and log in with your account.
2. On Ecotopia App, tap  on top right to scan QR code on HUB, and follow the instructions to turn them on, and deliver the settings to the device.

Note: "Setting delivery" is an important step to initialize your device. By doing this, the device can obtain the fine settings that are suitable for each sub-model. When your App is connected to network, it will obtain the correct settings from the cloud server. Without network connection, the App will use the information you cached in your mobile phone.

Then, HUB will start to collect its own data, scan and communicate with DEBUT devices assigned to it, and transmit data automatically, following its settings.

Note: As HUB can be used both as a terminal and as a gateway, it has two groups of settings. The settings you see on App and data center are its terminal settings. Its gateway settings (such as the scanning intervals, data downloading intervals, device entry/exit monitoring and reporting intervals, beacon locating switch, etc.) is not configurable on data center or App at this moment. It can also be set to Super Mode so it can collect data for all users' devices.

If you want to know more or change the default gateway settings, you can always contact [support@druid.tech](mailto:support@druid.tech).

# Usage Scenarios

## As Fixed Station

HUB can be fixed in a certain location to automatically scan for devices within its communication range, download data from them, deliver new settings to them, and monitor their entry/exit.

Below pictures show HUB deployment method. Use fasteners or tapes to fix HUB to a proper object. To achieve maximum communication range, it's suggested to deploy HUB or TAG G in an open space without obstacles (such as walls, woods, or hills), and lift it to at least 2m from the ground beneath.

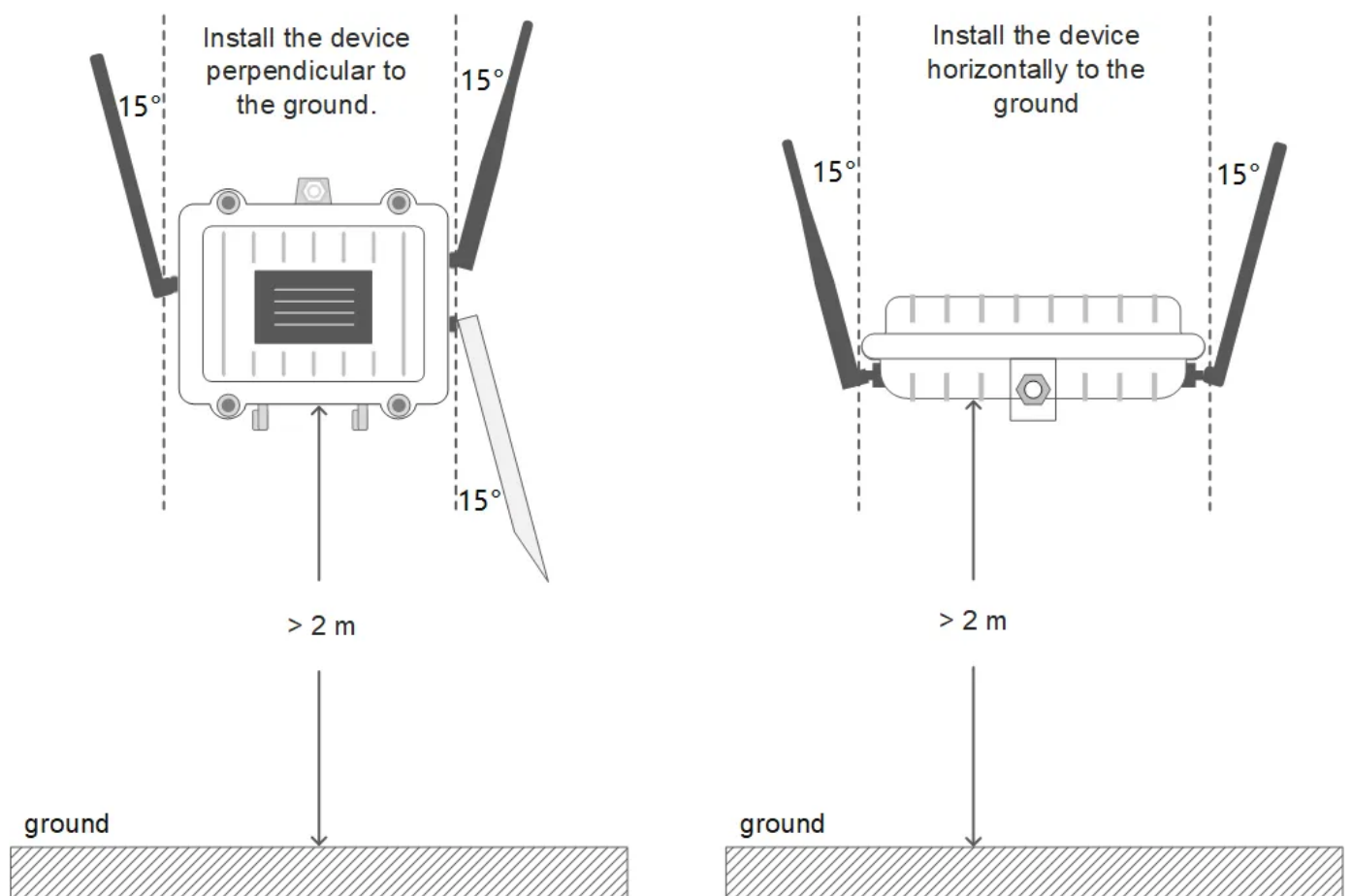

Note: For TAG G, use fastener or tapes to hang it to something like a branch

If the place you plan to deploy HUB does not have network signals, HUB can still download data from other DEBUT devices, but will not be able to upload data to cloud server. In this case, you can visit HUB once in a while and use your Ecotopia App to download all data stored in HUB. When you come back to a place with network, you can upload those data via mobile network connection.

## As mobile relay

As you know, a mobile phone can be used as a gateway for DEBUT devices, only with limited communication distance. But you can always use HUB as a relay to expand the communication distance to up to 1500 meters (depending on environment).

With HUB as a relay, you can connect your phone to devices remotely and perform real-time operations, such as showing all devices nearby on the phone screen, downloading their data immediately, changing their settings, or being guided to find a certain device.

Steps for using HUB as a relay:

1. Log in to your Ecotopia App, and make sure the HUB has been turned on.
2. Tap  icon on the App, and all DEBUT devices under the account are shown.
3. Tap to choose one device or tap and hold to choose multiple devices, and then choose the operation you want. Your phone will automatically connect to the device via HUB if the device is out of the range of your phone.

When you're carrying HUB while walking/driving during fieldwork, please watch out and take care of yourself.

---

## Recharging HUB

There are two ways to recharge the built-in battery of HUB:

- By power cable (provided along)
- By solar panel (provided along)

Note:

- Mind the orientation of male and female connectors when connecting solar panel to the HUB.

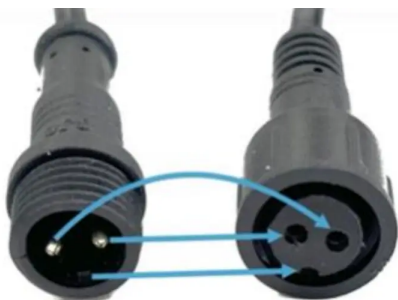

- It is suggested to seal the joint part with 706 silica gel and wrap it with electrical tape to avoid possible water penetration.



- TAG G is already with a solar panel. Its battery can be recharged by placing the device in direct sunlight.

---

## Data Service Fee Management

Data service fee consumption of a device in each month is determined by its data subscription status during that month. To optimize the data service fees for your devices, it is important to manage their data subscription status based on your needs.

In addition, please keep your account balance positive to avoid disruptions to data services. To recharge your data service fee, please contact your sales representative for assistance.

For more information, see [Ecotopia Data Service Fee](#).

---

## SATISFACTION GUARANTEE

Druid Technology offers triple satisfaction guarantee to relieve you from any worries.

### **6-Month Return & Refund (customized products not included)**

You can apply for return & refund within 6 months since the date of purchase if you are not satisfied with the device. You will cover data service fee incurred in the period.

Limitations: The device hasn't been deployed, altered or tampered with and should be without any cosmetic damages. It should function properly as remotely tested and confirmed by Druid.

### **1-Year Limited Warranty**



Your device enjoys 1-year limited warranty since the date of purchase. During the period, Druid will repair or replace, depending on the actual case and technical feasibility, any defective devices. You need to return the device to Druid for service.

Limitations: Warranty does not apply to defects resulting from improper maintenance or use<sup>[1]</sup>, physical damage, or operation outside environmental specifications.

## **DEBUT Renewal Plan (Optional)**

Apart from return & refund and limited warranty, you can purchase DEBUT Renewal Plan as a lifetime insurance that offers you a new device without condition. You can also purchase renewal plan for the replaced new device. After the service is used, the status of old device will turn to **Terminated**.

<sup>[1]</sup>Improper maintenance or use may cause permanent damage and affect warranty. Please read the following cautions carefully:

- Keep the surrounding environment temperature of the device under 60°C in any circumstances. Otherwise, permanent damage may happen to the device;
- Keep the device away from magnetic field or electric field (for example, a transformer);
- Take proper protection measures to prevent the device from falling on hard surfaces;
- Don't dismantle, alter or tamper with the device.
- Be sure to charge the battery periodically
  - at least 1 day every 2 weeks for models like ULTRA and NANO P1 lite
  - every 4 weeks for models like NANO/MINI/INTERREX/FLEX II
  - every 8~12 weeks for models like FLEX II Argos/FLEX II MAX/LEGO

After that, turn on the device, synchronize data and turn it off for storage. During the process, no need to change data subscription status. This is important to battery maintenance and can affect warranty.

When you dispose your device and/or other batteries, make sure that it is done sustainably.



## User Essentials

- [System Structures of DEBUT Series Devices](#)
- [Ecotopia Data Service Fee](#)
- [Important Tips for Test and Deployment](#)

## System Structures of DEBUT Series Devices

Understanding system structures for DEBUT series devices with different transmission methods not only facilitates customizing device settings and effective troubleshooting but also empowers you to make well-informed fieldwork arrangements and optimize device performance.

- [INTELINK Model System Structure](#)
- [Cellular Model System Structure](#)
- [Satellite Model System Structure](#)

## Cellular Model System Structure

All Druid models feature INTELINK transmission, making both the system structures for cellular models and [INTELINK models](#) applicable to cellular models.

Please note that the [INTELINK range](#) of cellular models is not currently optimized. In most scenarios, the INTELINK capability of cellular models is primarily utilized for basic functions such as turning on/off and setting delivery.

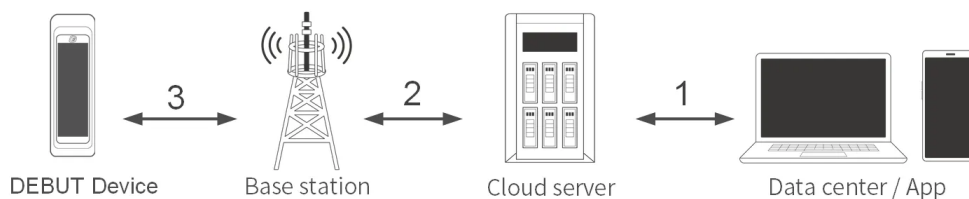

- Device settings can be changed on Ecotopia Web/app at any time, with the change immediately (1) synchronized to the server but not yet applied by the device.
- When a device (3) (2) communicates with the server via cellular network, it will get and immediately apply the latest device setting on the server, and then work accordingly.
- The device will (3) (2) transmit data collected to the server in upcoming transmission sessions via cellular network.
- In instances where the device has no access to cellular networks, the data is stored in the device's memory. The device memory has the capacity to store at least 460 days of data under standard settings.

**Exclusive Feature for Cellular Models:** A cellular device automatically wakes up every 7 days to attempt to establish a connection with the server, even when the device is turned off. Additionally, there is an option to schedule the device to power itself on, providing valuable assistance in scenarios where users may forget to activate the device before releasing the animal. Click [here](#) to know more.



# Satellite Model System Structure

All Druid models feature INTELINK transmission, making both the system structures for satellite models and [INTELINK models](#) applicable to satellite models.

Please note that the [INTELINK range](#) of satellite models is not currently optimized. In most scenarios, the INTELINK capability of satellite models is primarily utilized for basic functions such as turning on/off and setting delivery.

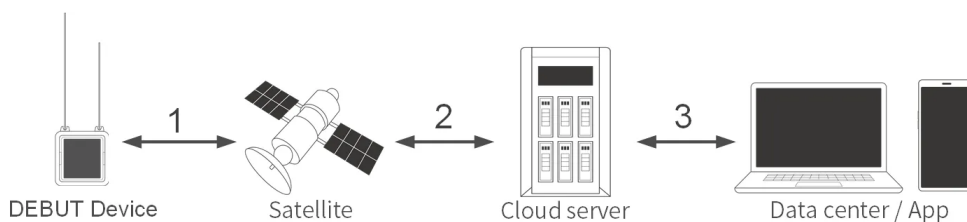

- The transmission between satellite devices and satellites is unidirectional, allowing data to be solely (1) transmitted from satellite devices to satellites, not the reverse.
- Therefore, it is crucial to establish and deliver the appropriate device settings to the satellite device before releasing the animal. Once the animal is released, any setting changes made on the server via Ecotopia Web/app cannot be delivered through satellite communication.
- Subsequently, the device will (1) (2) transmit the collected data to the server during upcoming satellite transmission sessions. Then you can access the data via Ecotopia Web/app anytime, anywhere. Iridium or Globalstar satellite models transmit data regularly as per the configured settings. The process is somewhat more intricate for Argos. Click [here](#) to learn more.

Please note that Iridium or Globalstar satellite devices are delivered ready for satellite transmission. In contrast, for Argos satellite devices, it is necessary to deliver settings to the devices to enable their functionality.

# INTELINK Model System Structure

All Druid models feature INTELINK transmission. As a result, this system structure applies to all models, including [cellular models](#) and [satellite models](#).

However, it's essential to note that models exclusively relying on INTELINK transmission are optimized for INTELINK range since it is their sole transmission method. Models with alternative transmission methods are not specifically optimized for INTELINK range, as they have their own transmission methods. Learn more about INTELINK range [here](#).

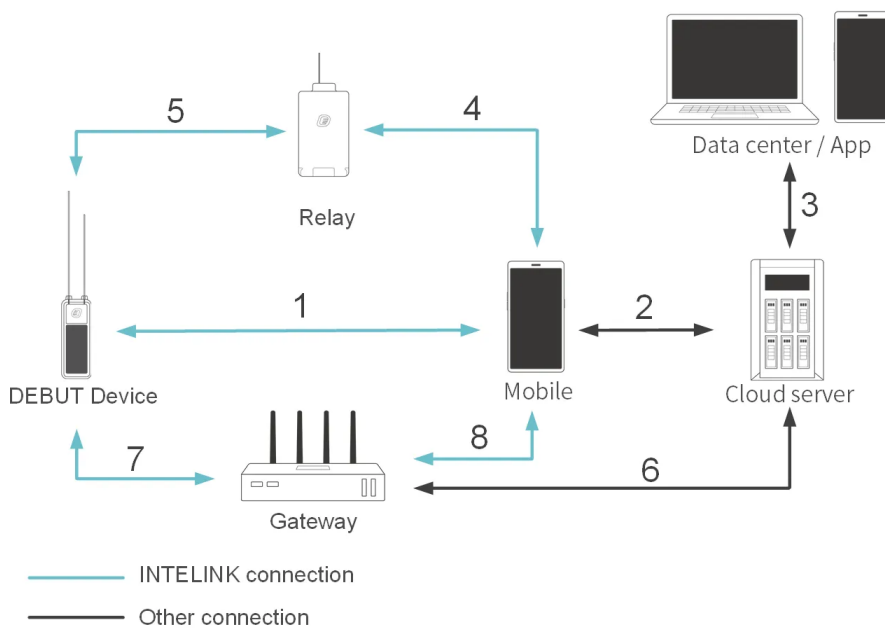

## Data Flow Patterns

### 1 ~ 2 ~ 3

- Device settings can be changed on Ecotopia Web/app at any time, with the change immediately (3) synchronized to the server but not yet applied by the device.
- When you (1) turn on the device and deliver the setting to the device via Ecotopia App, the App will (2) promptly retrieve the device's setting change from the server via the phone's



internet access and (1) deliver it to the device, where the setting change is then applied. In the field without internet access, ensure to [cache the setting change](#) in the Ecotopia App before fieldwork.

- After the device applies the setting, it operates according to the new setting.
- For models transmitting solely via INTELINK, data cannot be directly transmitted to the server. Instead, a gateway is needed. Your phone can serve as a gateway. You can (1) synchronize data via Ecotopia App on your phone and (2) upload the data to the server using the phone's internet connection.
- In instances where the device is outside the INTELINK range of any gateway, the data is stored in the device's memory. The device memory has the capacity to store at least 460 days of data under standard settings.
- Then you can access the data via Ecotopia Web/app anytime, anywhere.

### 5 ~ 4 ~ 2 ~ 3

- During fieldwork, when proximity to animals is limited, an INTELINK signal amplifier like QUEST, HUB, or TAG III G acts as a relay device. It (4) (5) extends the INTELINK range between your phone and the device, simplifying fieldwork. Learn more [here](#).

### 7 ~ 6 ~ 3

- Device settings can be modified on Ecotopia Web/app at any time, with the change immediately (3) synchronized to the server but not yet applied by the device.
- The gateway, such as HUB or TAG III G, (6) acquires the setting change during its next transmission session via the cellular network. The setting change is applied by the device when it (7) enters the INTELINK range of the gateway. Learn more [here](#).
- After applying the setting, the device operates accordingly. The data (7) is downloaded immediately from the device to the gateway when the device enters the INTELINK range of the gateway. The downloaded data is then (6) uploaded to the server during the gateway's subsequent transmission session.
- Then you can access the data via Ecotopia Web/app anytime, anywhere.

### 7 ~ 8 ~ 2 ~ 3

- In scenarios where the gateway lacks internet access in the field, preventing it from acquiring setting changes or uploading collected data to the server, you can cache your Ecotopia App. When at the gateway in the field, you can (8) deliver setting information from the App cache to the gateway and synchronize data from the gateway to your phone. The data can then be (2) uploaded to the server later using the phone's internet connection.



## Ecotopia Data Service Fee

You can find the following topics in this section:

- [What is Ecotopia Data Service?](#)
- [Ecotopia Data Service Pricing](#)
- [Billing System](#)
- [Data Subscription Status Management](#)

## What is Ecotopia Data Service?

Ecotopia data service encompasses all data-related offerings provided on Ecotopia, including Data Subscription, Data Platform Functions, and Cloud Service.

1. Data Subscription entails the feed of newly generated data, comprising GNSS data and environmental data, to your account. Additional Data Subscription\*, which encompasses data types beyond default GNSS and environmental data, is available as an optional service.
2. Data Platform Functions encompass various functionalities available on the Ecotopia web and App, such as data viewing, map tracking, and data analysis.
3. Cloud Service entails the storage and maintenance of data on cloud servers.

\* Additional Data Subscription is an optional service that includes data types other than default GNSS and environmental data, such as algorithm data and event data.

# Ecotopia Data Service Pricing

---

## Pricing for Data Subscription, Data Platform Functions and Cloud Service

For models utilizing different transmission methods, the pricing varies:

Model Type	Data Subscription (USD / month)	Data Platform Functions (USD / month)	Cloud Service (USD / month)
Cellular*	7.00	2.00	0.99
Intelink / LoRa	1.00		
Argos*	1.00		
Iridium*	21.49		

\* For cellular model, unlimited global roaming data transmission via 2G/3G/4G/5G network is included.

\* For Argos model, Argos ID application and transmission fee is NOT included. According to the requirement of CLS, users must apply for their own Argos account and IDs from CLS and pay the bills issued by CLS directly. Click [here](#) to know how.

\* For Iridium model, it includes Iridium ID application, activation, and a 1-year transmission package of SBD 12 (1 GNSS per hour, 1 transmission every 4 hours). The data fee might change if Iridium company changes the pricing rules. If a different Iridium data package is required, please contact your sales representative.

---

## Pricing for Additional Data Subscription

Data Type		Pricing
Algorithm data	Acceleration	free till 2024.05.31
	Magnetometry	free till 2024.05.31
	Behavior	free till 2024.05.31
	HF ODBA	1.00 USD / device / month
	ODBA	1.00 USD / device / month
Event data	Beacon	free till 2024.05.31
	Animal event	free till 2024.05.31
	Proximity	free till 2024.05.31

## How to Recharge

- Initial Recharge for Newly Purchased Devices

The Ecotopia data service fee is typically collected for one whole year upon the purchase of a new device. For example, for an Intelink model NANO, the yearly full data service fee amounts to 59.88 USD (calculated as  $12 * (\text{Data Subscription } 1.00 + \text{Data Platform Function } 2.00 + \text{Cloud Service } 0.99 + \text{ODBA } 1.00)$ ), while for HUB, the yearly full data service fee amounts to 119.88 USD (calculated as  $12 * (\text{Data Subscription } 7.00 + \text{Data Platform Function } 2.00 + \text{Cloud Service } 0.99)$ ) because ODBA is usually not needed for HUB. This initial recharge ensures uninterrupted service for the specified period.

- Flexible Recharges

Following the initial recharge, users have the flexibility to add funds to their Ecotopia account at any time and with any amount they choose. For further assistance with recharges, please reach out to your sales representative.

- Data Service Pool

The recharged funds are deposited into the user's Ecotopia account, creating a pooled resource. This collective fund allows all devices under the same account to draw from it to cover their respective data service fees, ensuring seamless and convenient management of resources.

**Note:** Pricing rules are subject to change without further notice.



# Billing System

To empower users with flexibility in managing their Ecotopia data service fees and optimizing their usage, Druid provides a user-friendly billing system based on the Data Subscription Status of each device.

---

## Data Subscription, Data Platform Functions and Cloud Service

Different combinations of Ecotopia data service items are available for devices under various Data Subscription Statuses, with corresponding charges. The table below illustrates the Data Subscription Status and the associated Ecotopia data service items.

Status	Data Subscription	Data Platform Functions	Cloud Service
Active	✓	✓	✓
Inactive	X	✓	✓
Suspended	X	X	✓
Terminated	X	X	X

Users can modify the Data Subscription Status of devices as needed via the Ecotopia web and App. (Learn how on Ecotopia web [here](#) and Ecotopia App [here](#))

---

## Additional Data Subscription

For devices with Active status, users have the option to subscribe to Additional Data. Click [here](#) for instructions on ODBA subscription, and contact us for information on other Additional Data Subscription options.



---

## How is the Ecotopia data service fee charged?

The Ecotopia data service fee is billed monthly. On the 5th of each month, the system deducts the fee for the previous month based on the device's Data Subscription Status.

For instance, let's consider a cellular model FLEX II 4G with an Active Data Subscription Status and an Additional Data Subscription for ODBA at the time of billing. In this scenario, the charge for the previous month would be 10.99 USD (calculated as Data Subscription 7.00 + Data Platform Function 2.00 + Cloud Service 0.99 + ODBA 1.00).

To streamline billing and enhance user experience, after the first change in Data Subscription Status for a device, users must wait for a 2-month period before making subsequent status changes.

Users can conveniently access their billing records by visiting **Ecotopia > Billing**, ensuring transparency and easy management of their data service fees.

## Data Subscription Status Management

Check below instructions on how to manage data subscription status:

- When a device is newly purchased, the device is "Suspended" by default. You need to change it to Active to test and use it.
- When a device is newly purchased and you have no plan to use it soon, you can keep it at Suspended.
- When a device has collected some valuable data but you don't expect further useful data from the device due to various reasons (for example, the study case closed, the device dropped, the animal died or go missing), you can set it to Inactive to keep using our data platform to view or analyze the collected data.
- If you want to remove a device from your account, you can set it to Terminated.

**Note:** Terminated device cannot be restored. Make sure that you have downloaded all the needed data.

## Important Tips for Test and Deployment

- [Important Don'ts for Test](#)
- [Important Dos for Deployment](#)

## Important Don'ts for Test

- **Don't Skip Familiarization**

Get acquainted with Druid's tracking system to optimize usage and gather valuable data. Find model-specific details [here](#).

- **Don't Test with a Low Battery**

Ensure the device battery is sufficiently charged. A low battery will prevent the device from working properly (due to working voltage thresholds) and affect test results.

- **Don't Place Directly on Hot Surfaces**

Avoid placing the device directly on surfaces like concrete floor to prevent extreme heat. Use insulation materials like plastic foam.

- **Don't Place Near Interference Sources**

Avoid placing the device near metal objects (like fences or window frames), liquid surfaces, balconies, high walls, electric or magnetic fields (such as transformers), or under a roof, as these can interfere with signals.

- **Don't Test Inside Cars**

Do not place the device inside a car, especially near the front windshield, as this can cause extreme heat and signal interference.

- **Don't Place Devices Too Close Together**

Keep devices at least 1 meter apart to prevent signal interference.

- **Don't Bring Indoors**

Avoid bringing the device indoors during the test to prevent battery drain and test disruption. If necessary, turn the device off.

# Important Dos for Deployment

- **Conduct a Pre-Deployment Test**

Test the device for at least one month before deployment to ensure functionality and familiarize yourself with the tracking system.

- **Verify Data Transmission**

Ensure cellular and satellite transmission models collect data and transmit it via methods other than Intelink at least three times before deployment.

- **Fully Charge the Battery**

Fully charge the device battery before deployment to avoid data gaps during the initial stage.

- **Activate Data Service**

Ensure the device's data subscription status is set to Active and that additional data is subscribed before deployment.

- **Set Appropriate Intervals**

Avoid setting too frequent GNSS and transmission intervals. GNSS and transmission Intervals shorter than 1 hour are for test purposes only. Consult the support team if necessary.

- **Adjust for Nestling Stage**

Set the working interval to 1 day or longer if the individual is still nestling. Shorten intervals only if the individual has left the nest.

- **Turn On and Deliver Settings**

Ensure the device is turned on and settings are delivered before deployment. Cellular models can be turned on remotely, but others cannot.

- **Whitelist Terminal Devices**

Add terminal devices to the HUB whitelist and ensure the HUB has transmitted once so it can recognize them.

- **Check Solar Panel Coverage**

Ensure the solar panel is not partially or fully covered by feathers. Consider the animal's body

movement and molting.

- **Correct Device Placement**

Position the device correctly during deployment. The solar panel should face upwards or outwards. The side with the Druid logo should face the bird's head or be positioned upwards. External antennas should point towards the bird's tail.

## INTELINK Introduction

INTELINK is called Intelligent Linking, which is an ultra-low power communication technology based on Bluetooth. With the support of INTELINK, DEBUT devices can directly establish connections with ordinary smart phones and other DEBUT products to realize many different functions and generate new data types through the interaction between different devices. You can perform the following operations with INTELINK:

- [Turning on device](#)
- [Data synchronization](#)
- [Setting delivery](#)
- [Data tagging](#)
- [Editing tag result](#)
- [Firmware upgrading](#)
- [Device finding](#)
- [Using relay devices](#)
- [Device reset](#)

Currently, INTELINK is not supported on iPad.





## Turning On Device

Make sure Bluetooth is enabled on your phone and authorized to Ecotopia App. Follow below steps to turn on devices. (Turning off is much the same procedure.)

**Note:** We recommend that you always turn on a device with your mobile phone connected to network, especially for the first time of device initialization. If you plan to initialize your device in an environment without network connection, make sure that you have cached all necessary information in your mobile phone beforehand. For details, see [Cache management](#).

Step 1:

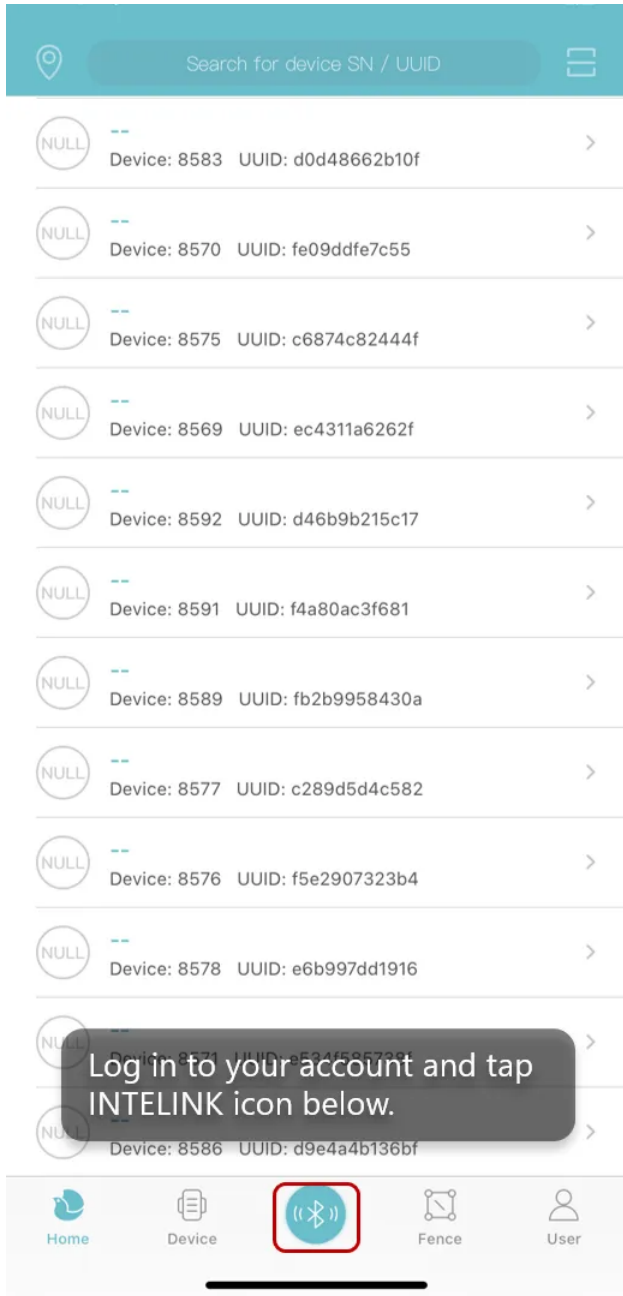

Step 2:



Step 3:

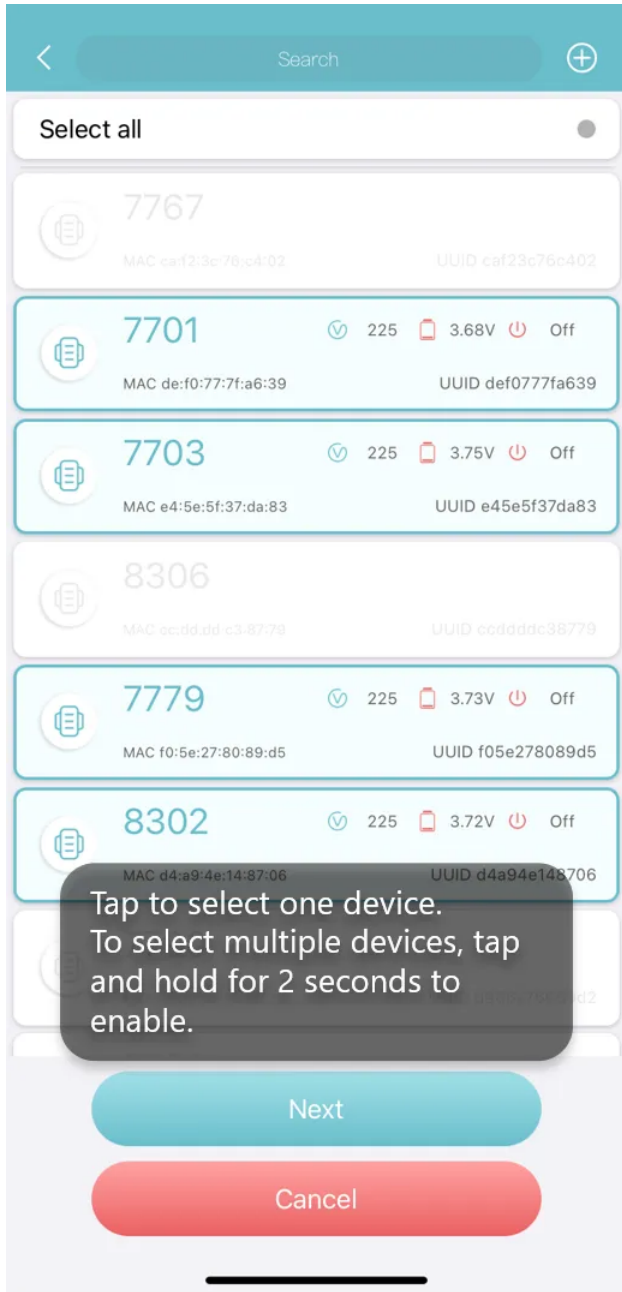

Step 4:

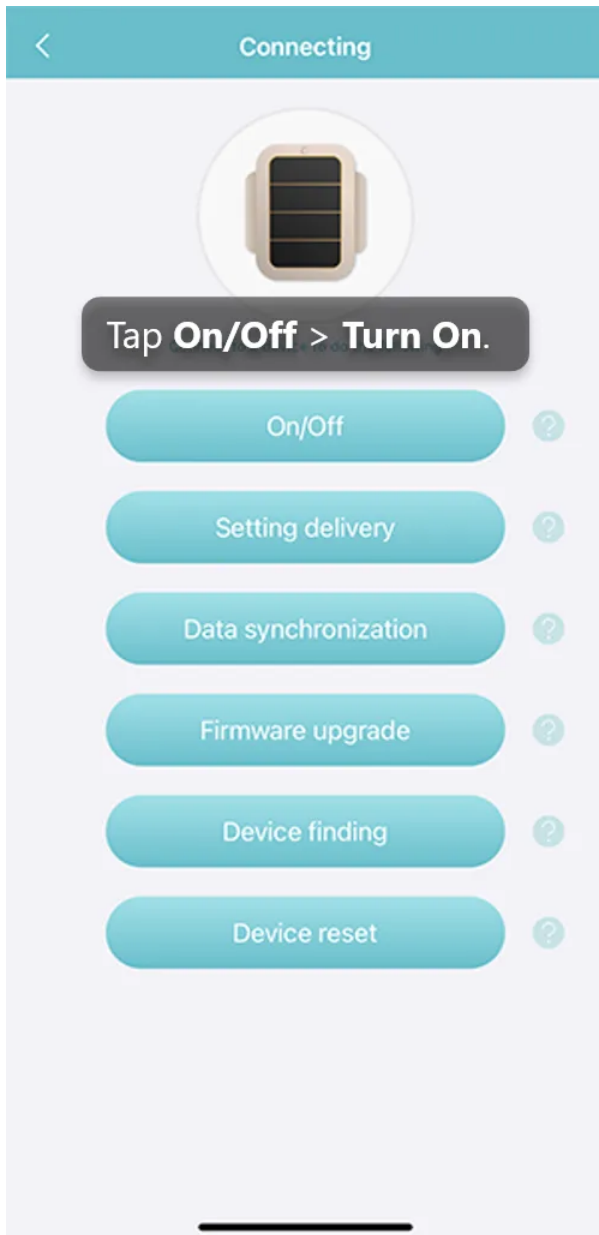

Step 5:

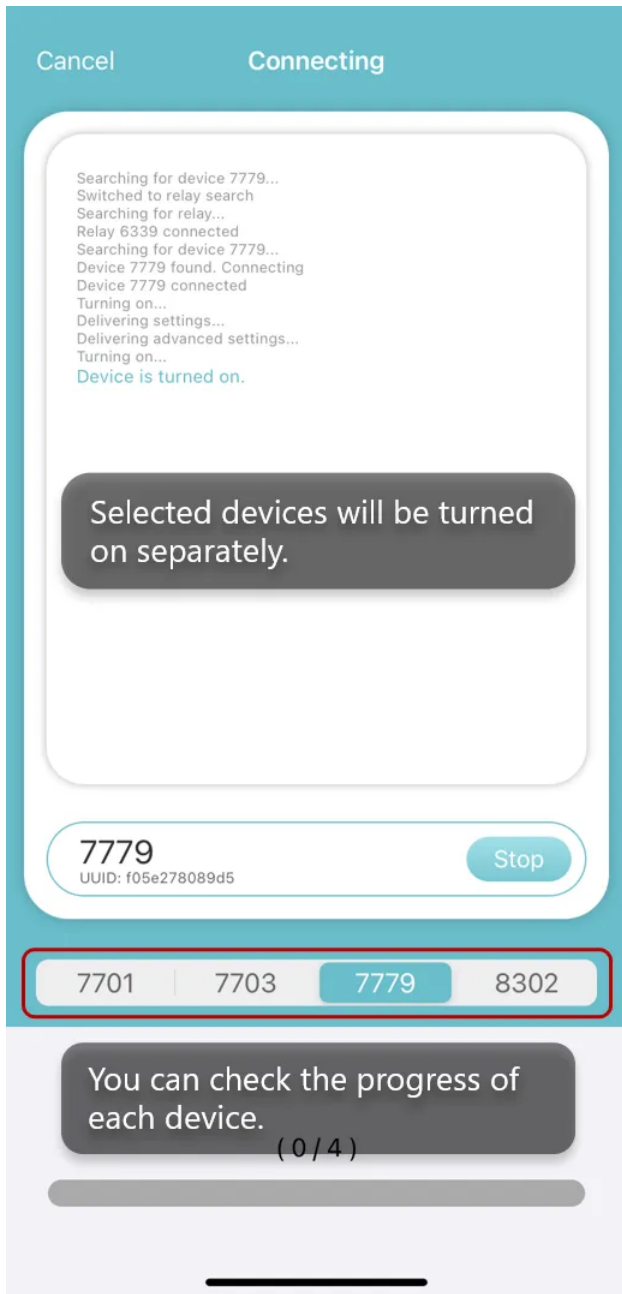

**Note:** After turning on a device, you must deliver settings to the device. [Setting delivery](#) is an important step to initialize your device. By doing this, the device can obtain the fine settings that are suitable for each sub-model. When your App is connected to network, it will obtain the correct settings from the cloud server. Without network connection, the App will use the information you cached in your mobile phone.

# Data Synchronization

Make sure that Bluetooth is enabled on your phone and authorized to Ecotopia App. Follow below steps to synchronize the data from the devices to the cloud server.

Step 1:

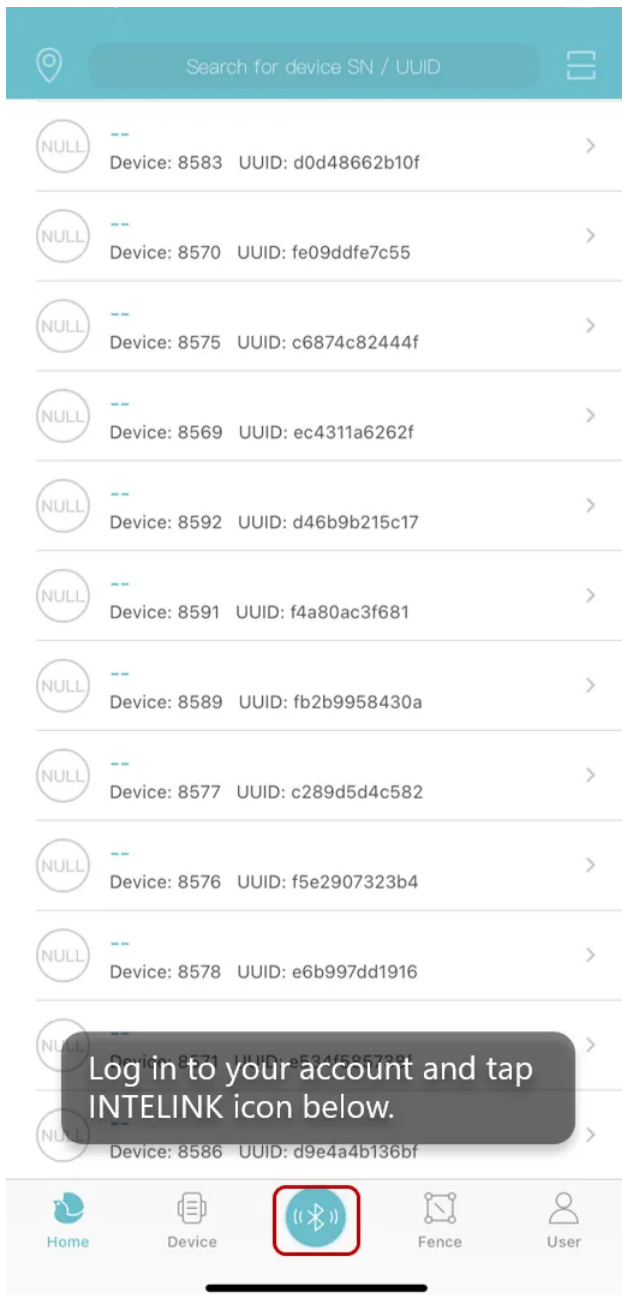

Step 2:

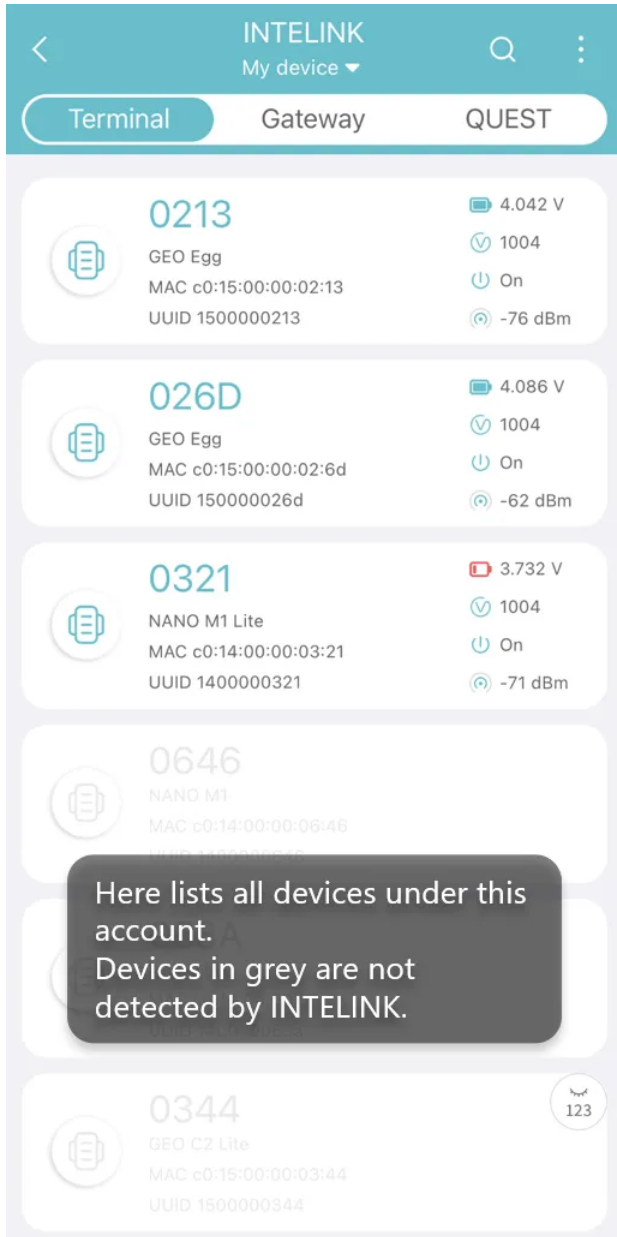

Step 3:



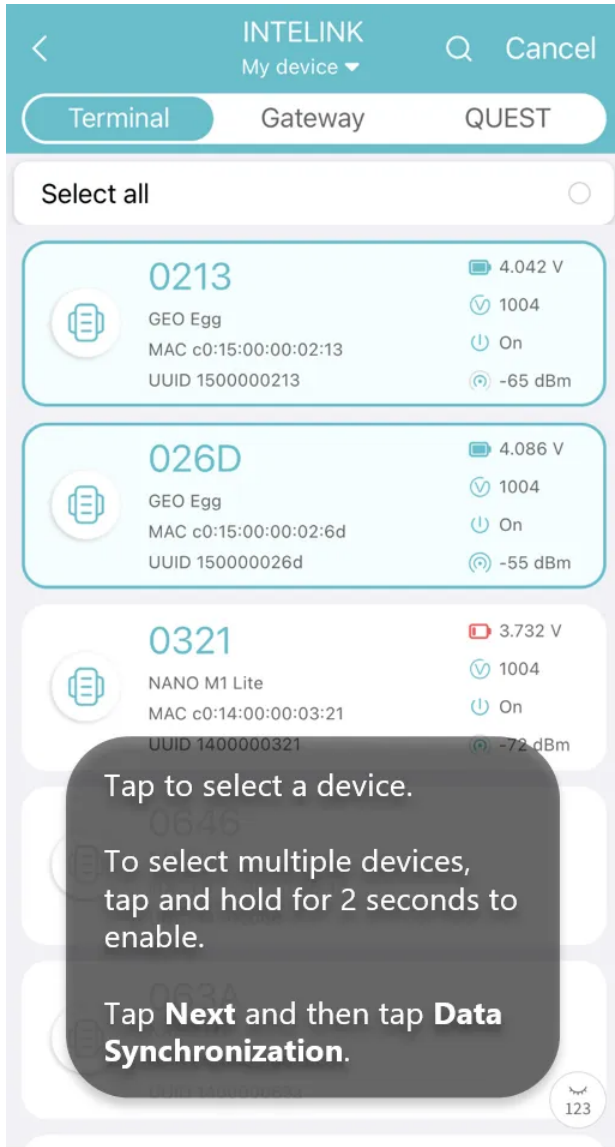

Step 4:

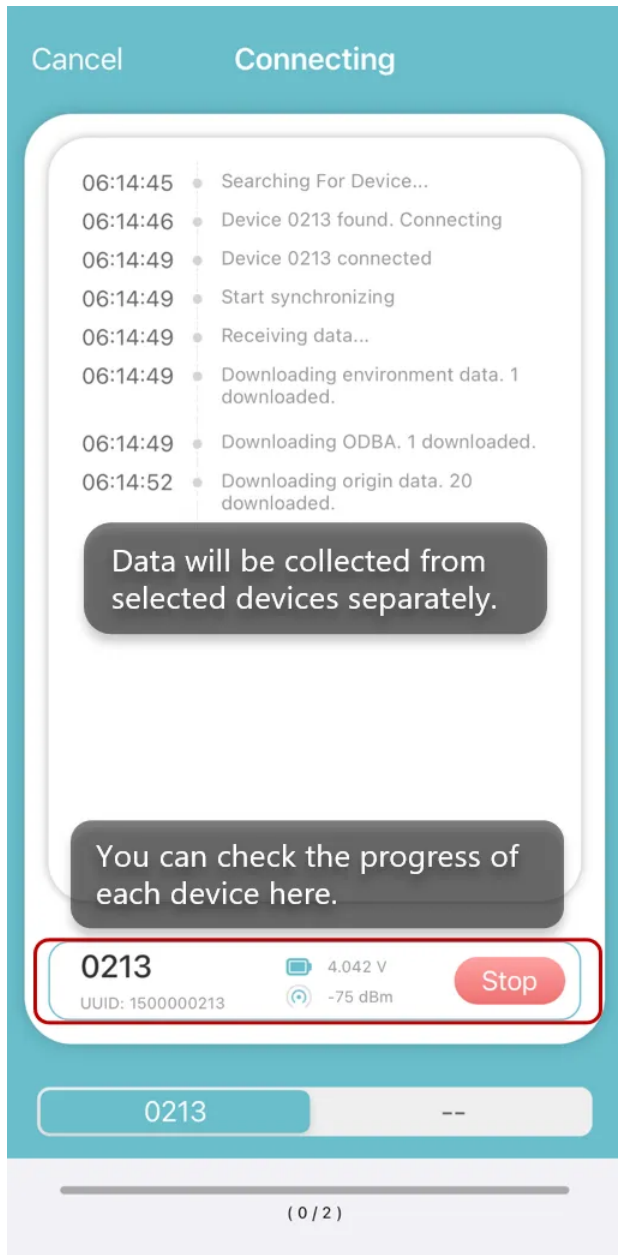

## Note

- If a large volume of data is stored on the device, such as raw acceleration data or other data types collected over an extended period, the data synchronization process may take multiple rounds to complete. Each round takes approximately 16 minutes. In such cases, please be patient and try one or more additional data synchronization attempts to ensure that all data has been successfully synchronized.
- If your mobile phone is not connected to the internet during data synchronization, the synchronized data will be temporarily stored on your phone. However, this data cannot be automatically uploaded to the server even after your phone regains internet access. To upload the stored data, you will need to perform a manual upload once your phone is connected to the internet. Follow these steps:

1. Open the Ecotopia App and navigate to **User > Additional Features > Data Synchronization**.
2. Tap on **Upload**.
3. Select **Upload All** to initiate the upload process for all stored data.

This manual upload process ensures that the data synchronized while offline is securely transferred to the server once an internet connection is available.

## Setting Delivery

Make sure that Bluetooth is enabled on your phone and authorized to Ecotopia App. Follow below steps to deliver the settings from the cloud server to the devices.

**Note:** Keep App connected to network during setting delivery. If you plan to deliver the setting in an environment without network connection, please cache all necessary information in your mobile phone beforehand. See [Cache management](#) for more information.

Step 1:

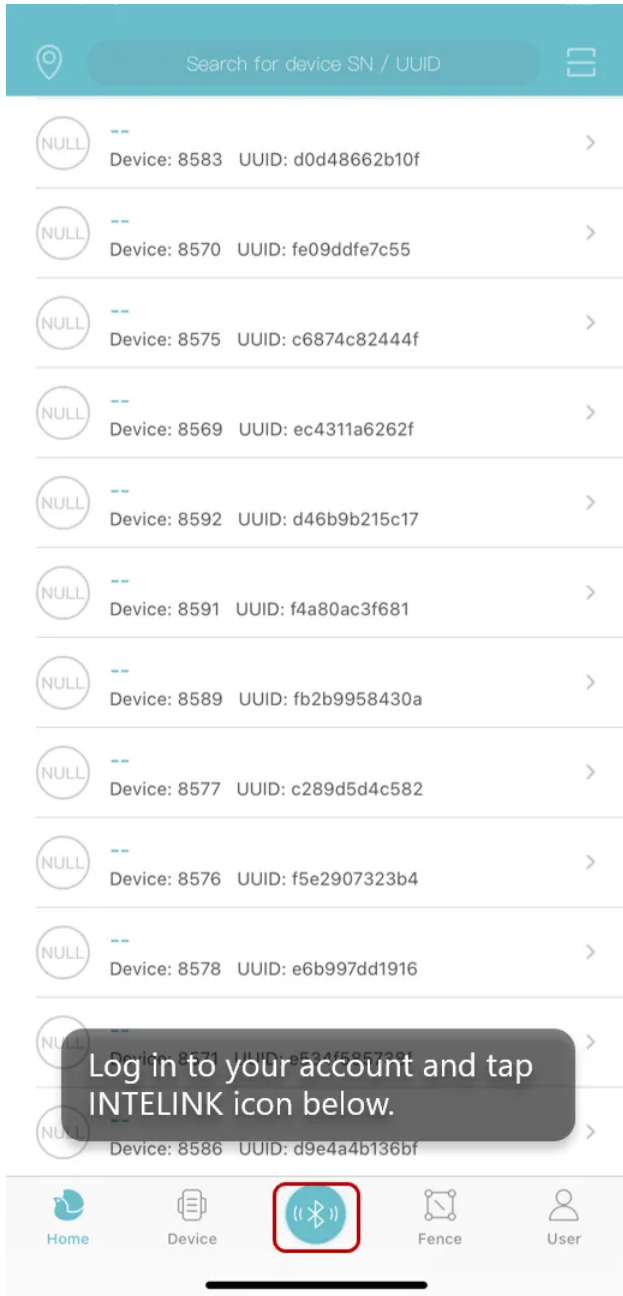

Step 2:



Step 3:

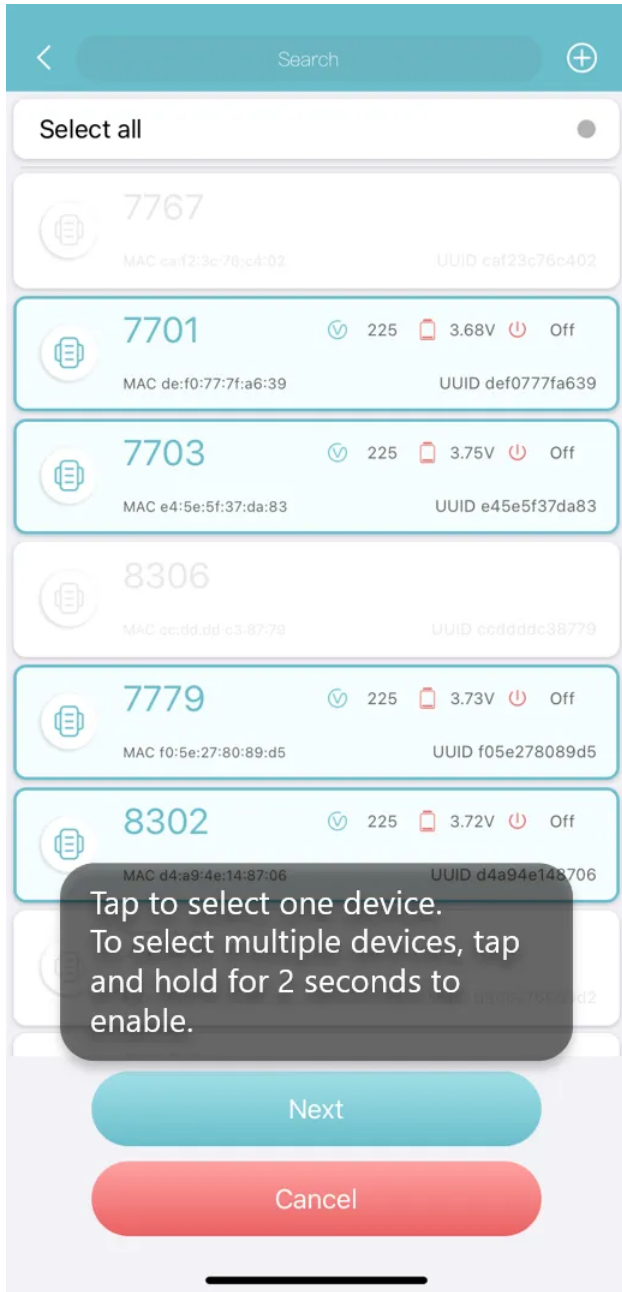

Step 4:

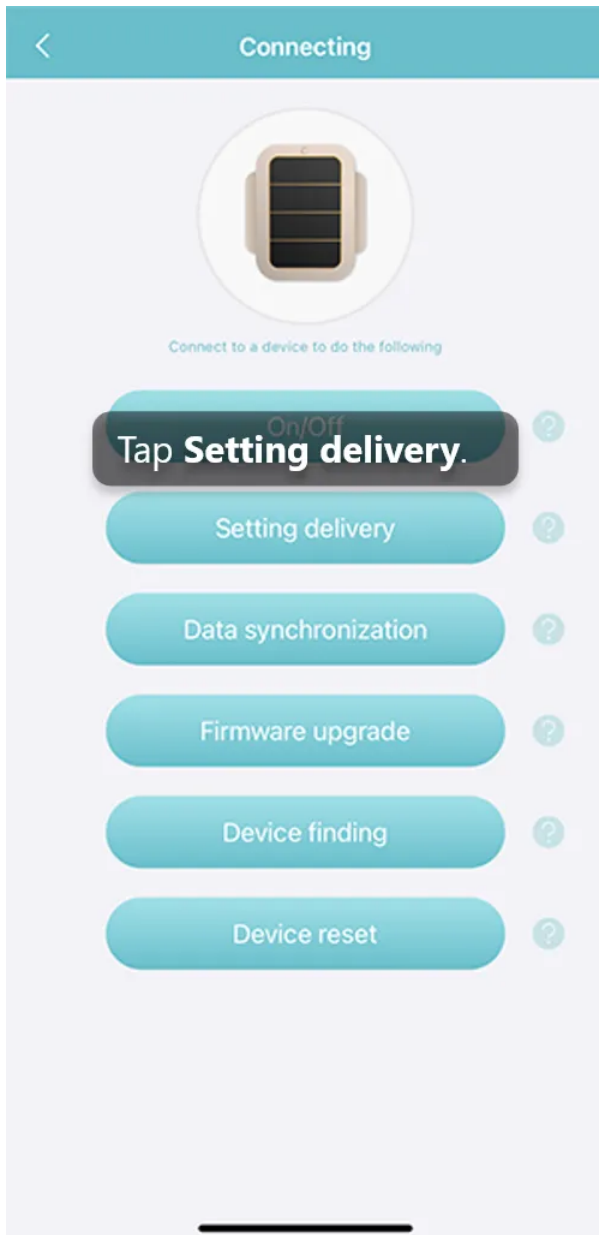

Step 5:



Cancel

Connecting

Searching for device 7779...  
Device 7779 found. Connecting  
Device 7779 found. Connecting  
Device 7779 found. Connecting  
Device 7779 found. Connecting  
Device 7779 connected  
Delivering settings...  
Delivering advanced settings...  
Setting delivered

Settings will be delivered to selected devices separately.

7701

7703

7779

8302

You can check the progress of each device.

1 / 4

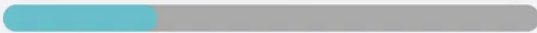

# Data Tagging

Make sure Bluetooth is enabled on your phone and authorized to Ecotopia App. Follow below steps to tag the data.

Step 1:

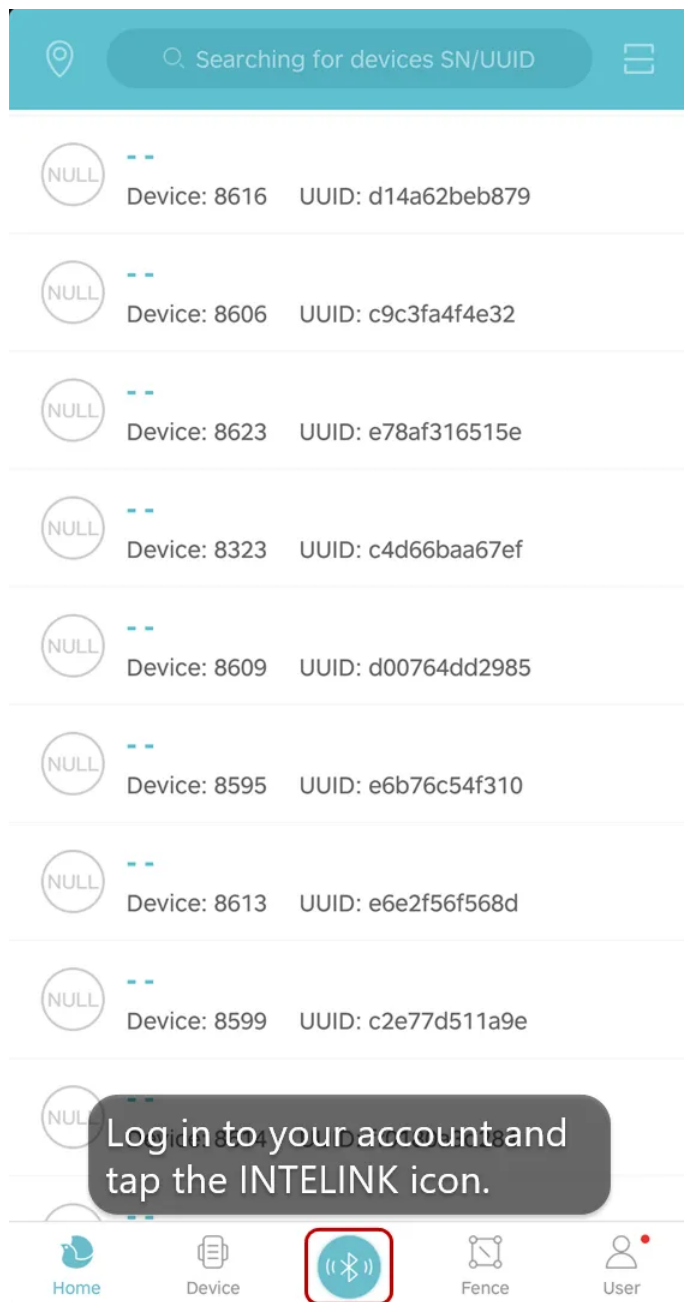

Step 2:

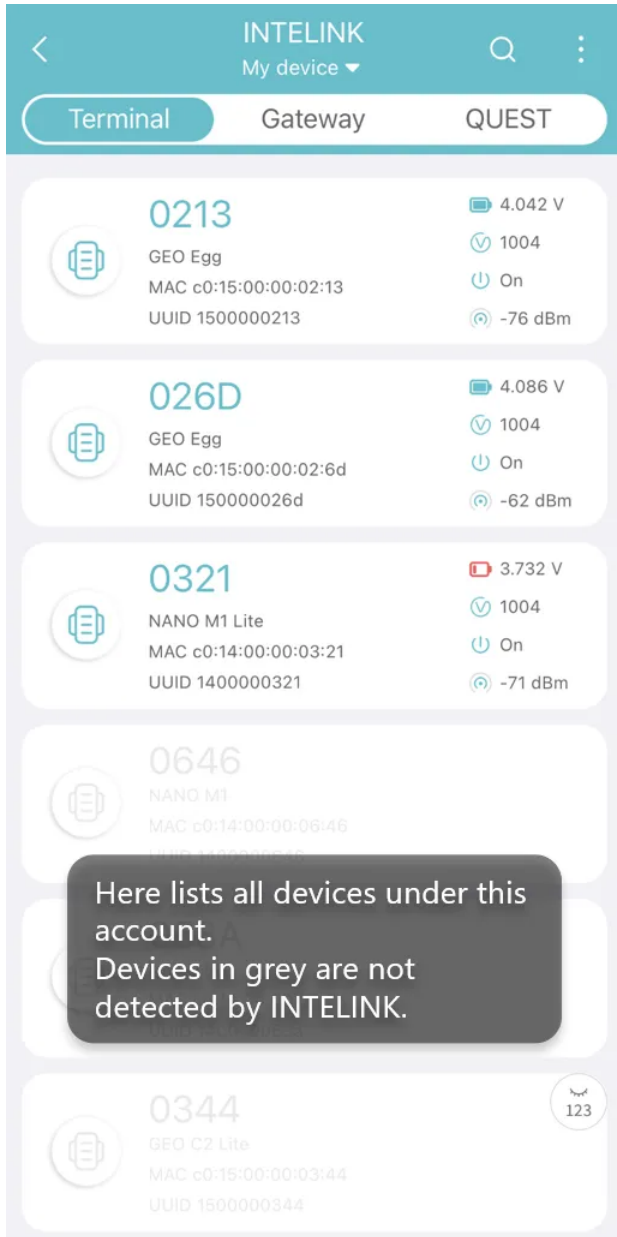

Step 3:

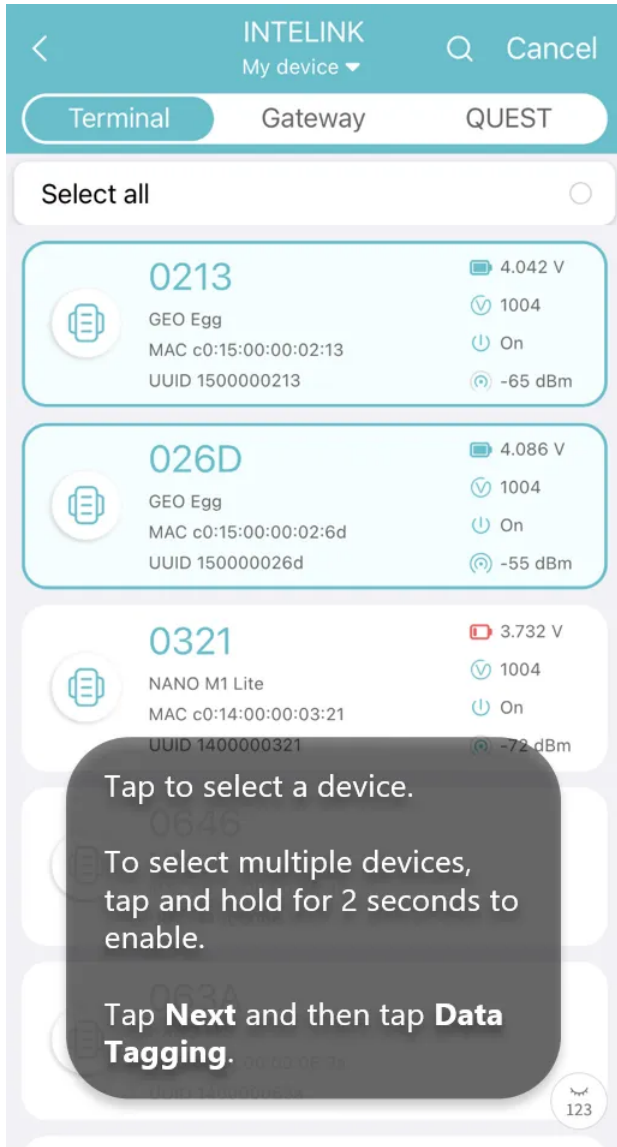

Step 4:

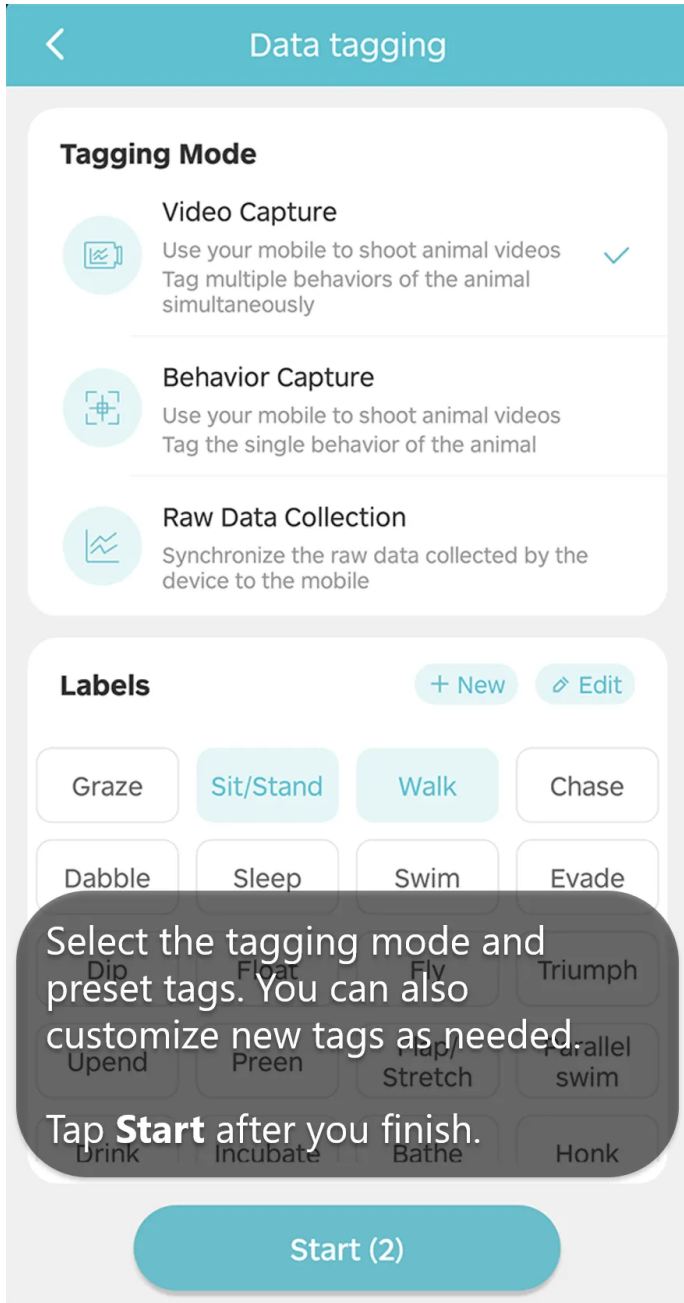

Step 5:

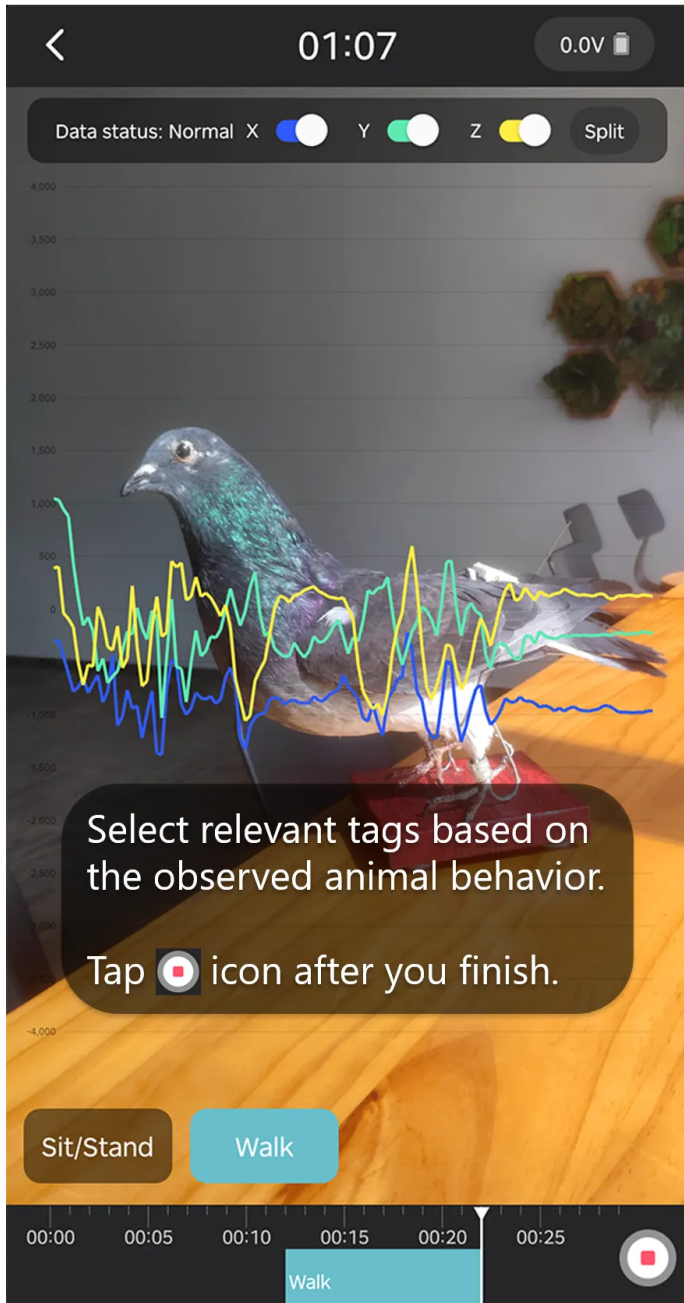

Step 6:

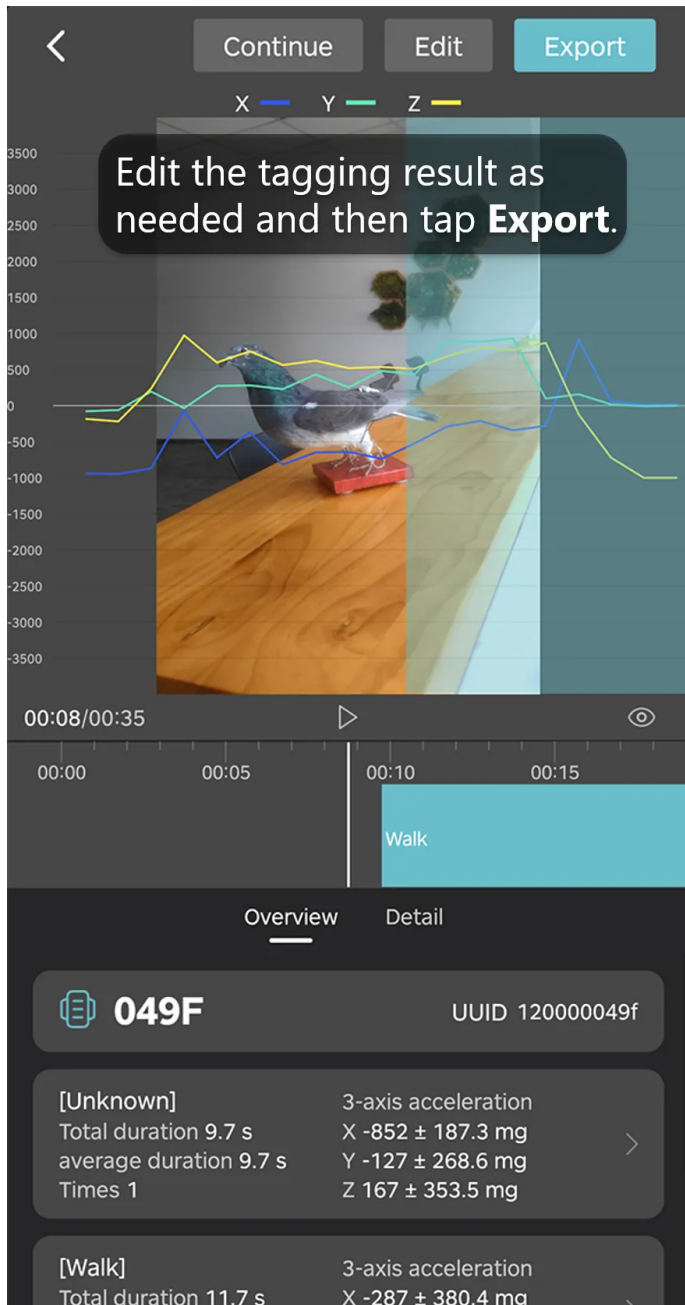

For more information on tag editing, see [Editing tag result](#).

Step 7:

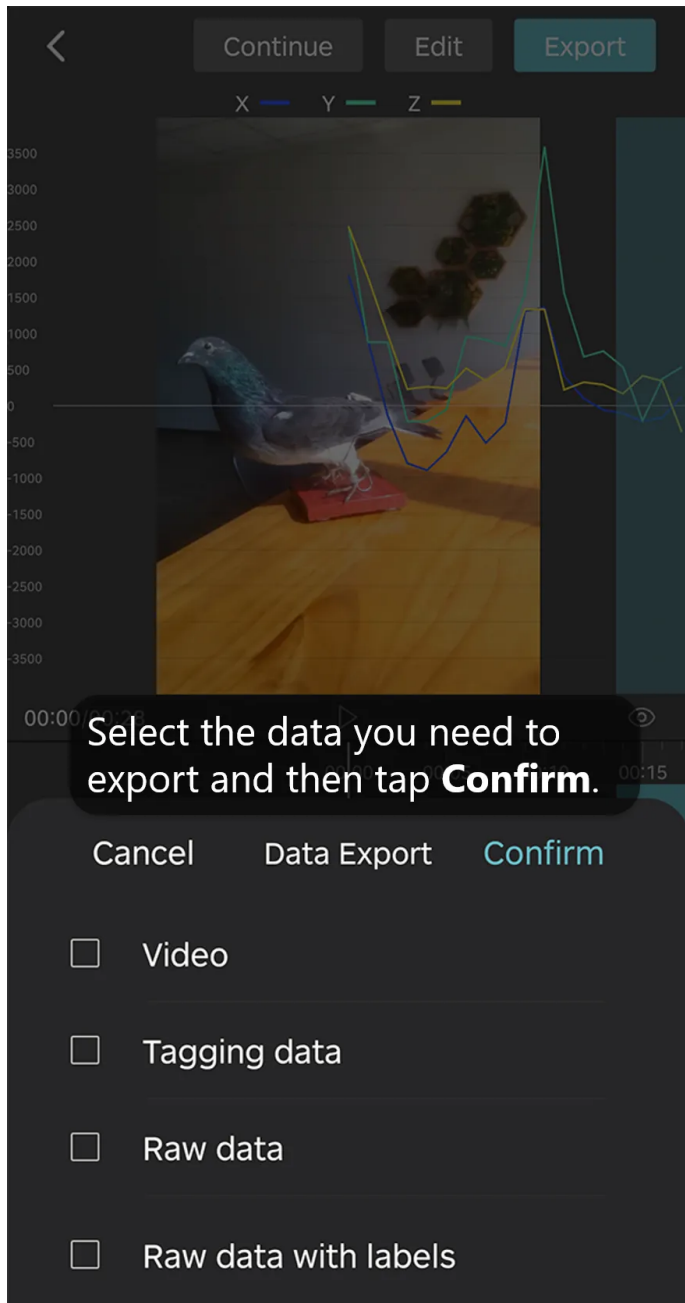

You can export the following data:

- Video

Video captured during the data tagging

- File format of Android: <UUID>[video]-<yyyy\_mmdd\_hhmm\_ss\_os3>.mp4
- File format of iOS: <UUID>-<yyyy\_mmdd\_hhmm\_ss\_os3>[Video].mp4

- Tagging data

File with behavior label and timestamp

- File format of Android: <UUID>[behavior]-<yyyy\_mmdd\_hhmm\_ss\_os3>.csv
- File format of iOS: <UUID>-<yyyymmdd\_hhmmss\_os3>[Behavior].csv



- Data field explanation:
  - Start: Start time of a behavior
  - End: End time of a behavior
  - Tag: Selected label of a behavior

- Raw data

ACC raw data collected during the data tagging

- File format of Android: <UUID>[acc]-<yyyy\_mmdd\_hhmm\_ss\_os3>.csv
- File format of iOS: <UUID>-<yyyy\_mmdd\_hhmm\_ss\_os3>[Acc].csv
- Data field explanation:
  - Collecting time: Time the device collects data, accurate to milliseconds
  - X: Value of X-axis in 1/1024 g on the three-axis acceleration sensor
  - Y: Value of Y-axis in 1/1024 g on the three-axis acceleration sensor
  - Z: Value of Z-axis in 1/1024 g on the three-axis acceleration sensor

**Note:** The Collecting time exported by the Android system represents the duration elapsed since the beginning at each instance, measured in milliseconds and in numerical format. To facilitate your data processing, please refer to the code at the end to convert the Collecting time from milliseconds to complete timestamps.

- Raw data with labels

ACC raw data with behavior label collected during the data tagging

- File format of Android: <UUID>[acc+behavior]-<yyyy\_mmdd\_hhmm\_ss\_os3>.csv
- File format of iOS: <UUID>-<yyyy\_mmdd\_hhmm\_ss\_os3>[Behavior & Acc].csv
- Data field explanation:
  - Collecting time: Time the device collects data, accurate to milliseconds
  - X: Value of X-axis in 1/1024 g on the three-axis acceleration sensor
  - Y: Value of Y-axis in 1/1024 g on the three-axis acceleration sensor
  - Z: Value of Z-axis in 1/1024 g on the three-axis acceleration sensor
  - Tag: Selected label of a behavior

**Note:** The Collecting time exported by the Android system represents the duration elapsed since the beginning at each instance, measured in milliseconds and in numerical format. To

facilitate your data processing, please refer to the code at the end to convert the Collecting time from milliseconds to complete timestamps.

Please note that the time included in the file name and the time within the file content are both in the UTC+0 time zone.

After you export the data, you can tap **User > Additional features > Data tagging** to view the tagging history.

Please refer to the following R code to convert the Collecting time from milliseconds to complete timestamps.

R

```
# This Code Can Be Used To Process Accelerometer (acc) Or Accelerometer With Behavior  
# However, These Two Types Of Data Cannot Be Processed Together And Need To Be  
# Make Sure You Have Installed The Stringr And Dplyr Packages
```

```
library(stringr)
```

```
library(dplyr)
```

```
# Place Your Files In The Corresponding Folder
```

```
folder_path <- "/Users/druid/Desktop/data_tagging/tag"
```

```
file_list <- list.files(folder_path, pattern = "*.csv", full.names = TRUE)
```

```
data_list <- lapply(file_list, function(file) {
```

```
  file_data <- read.csv(file)
```

```
  # Extracting ID and timestamp information
```

```
  file_name <- basename(file)
```

```
  file_parts <- unlist(str_split(file_name, "[-\\.]"))
```

```
  UUID <- gsub("\\[.*\\]", "", file_parts[1]) # Remove [acc+behavior]
```

```
  timestamp <- file_parts[2]
```

```
  # Parsing timestamp information
```

```
  year <- substr(timestamp, 1, 4)
```

```
  month <- substr(timestamp, 6, 7)
```

```
  day <- substr(timestamp, 8, 9)
```

```
  hour <- substr(timestamp, 11, 12)
```

```
  minute <- substr(timestamp, 13, 14)
```

```
  second <- substr(timestamp, 16, 17)
```

```
  millisecond <- substr(timestamp, 19, 21) # Extract millisecond part
```

```

# Formatting data into time format, UTC timezone
time_str <- paste(year, month, day, hour, minute, second, sep = "-")
time1 <- as.POSIXct(time_str, format = "%Y-%m-%d-%H-%M-%OS", tz = "UTC")

# Calculate time column, including milliseconds
file_data$time <- time1 + (file_data$Collecting.time + as.numeric(millisecond
file_data$time <- format(file_data$time, format = "%Y-%m-%d %H:%M:%OS3", tz =

# Add ID and remove X.1 column
file_data$UUID <- UUID
file_data <- file_data[, -which(names(file_data) == "X.1")]

return(file_data)
})

# Due To Time Format Conversion In Calculations, The Results May Differ By 0.00
tag_data <- bind_rows(data_list)

# Export File, You Can Customize The Filename
write.csv(tag_data, "tagging.csv")

```

# Editing Tag Result

Follow the instruction below to edit the tag result.

## Editing tagged content

1. Tap the tagged content.

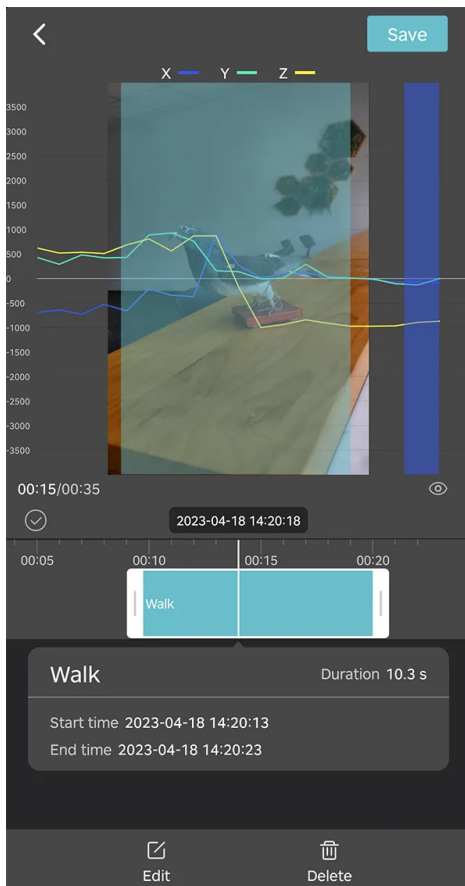

2. Edit the content as needed.

You can edit the following content.

- Drag the beginning or end of the clip to make the clip shorter or longer.
- At the bottom of the screen, tap **Edit** to assign a different label.
- At the bottom of the screen, tap **Delete** to delete the label (the video will not be deleted).

3. Tap **Save** after you finish.

## Editing untagged content

1. Move the timeline to a place where the content is not tagged.

2. Tap the + icon.

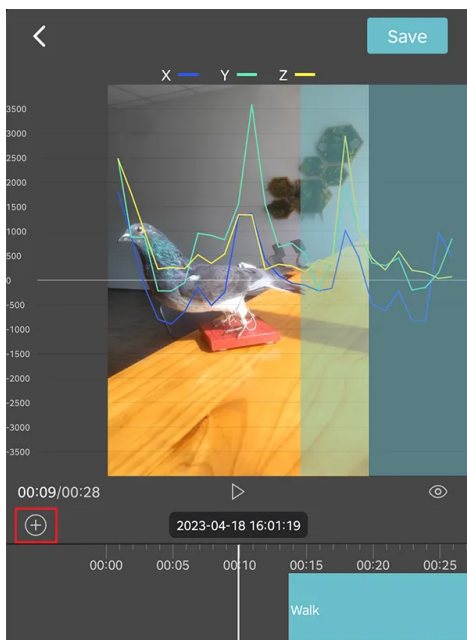

3. Edit the content as needed.

You can edit the following content.

- Drag the beginning or end of the clip to make the clip shorter or longer.
- At the bottom of the screen, tap **Edit** to assign a different label.
- At the bottom of the screen, tap **Delete** to delete the label (the video will not be deleted).

4. Tap **Save** after you finish.

# Firmware Upgrading

Follow below steps to upgrade the firmware. Before you start, make sure that the Bluetooth is enabled on your phone and authorized to Ecotopia App. If you need to do the upgrade at places where the network connection is not available, you must download the firmware in advance using [firmware management](#) feature.

Step 1:

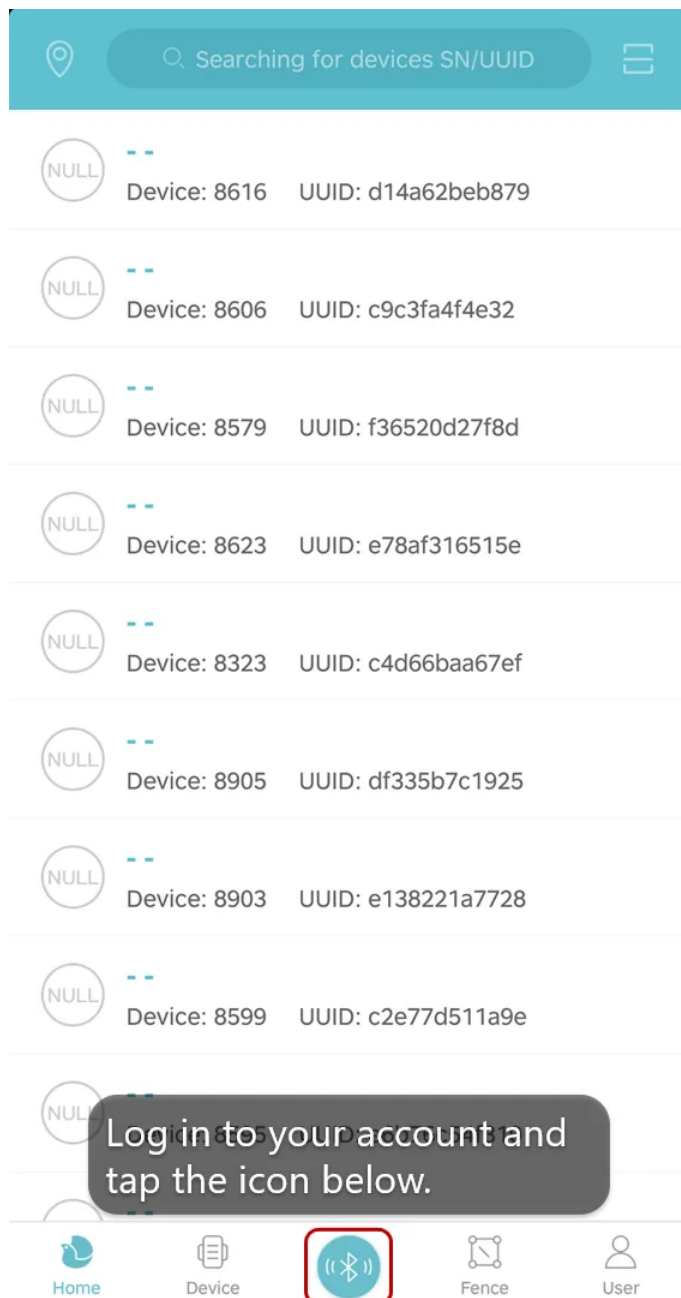

Step 2:

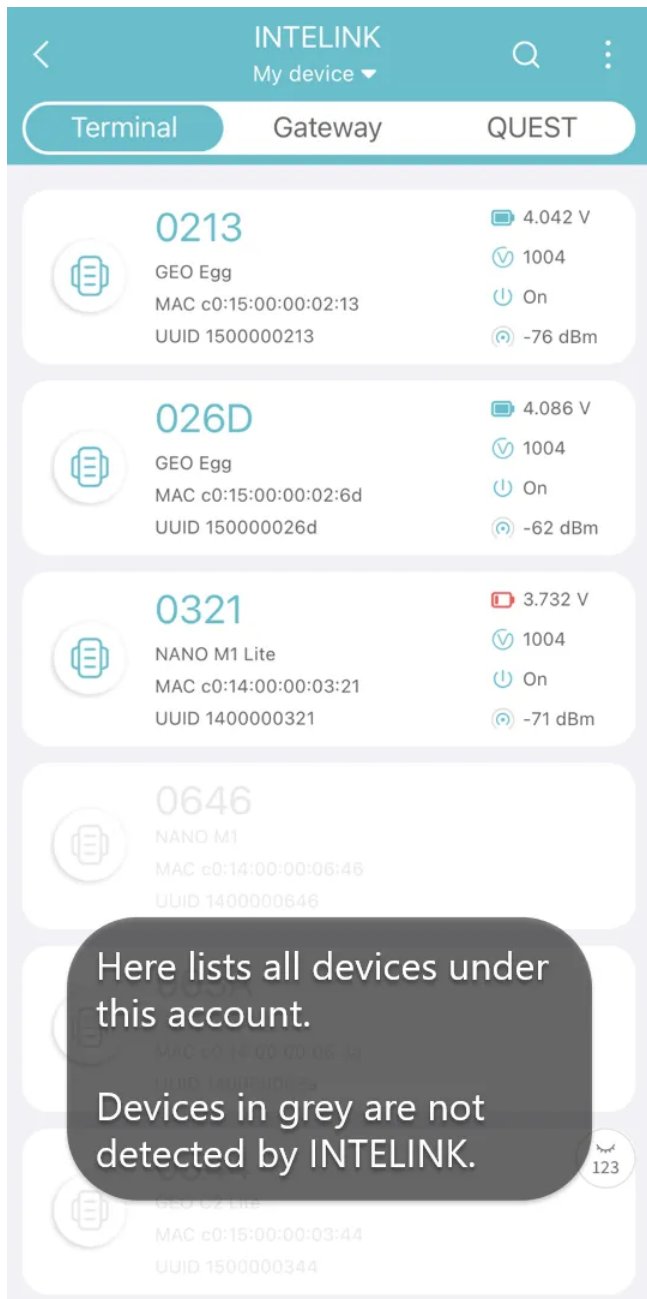

Step 3:

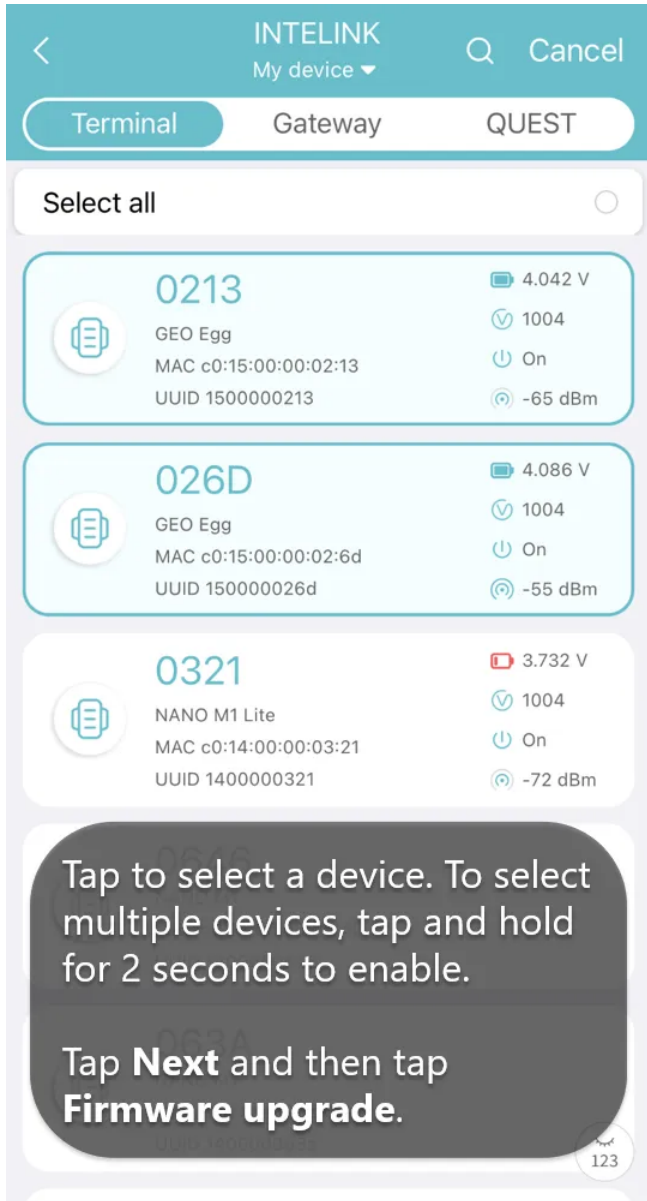

Step 4:



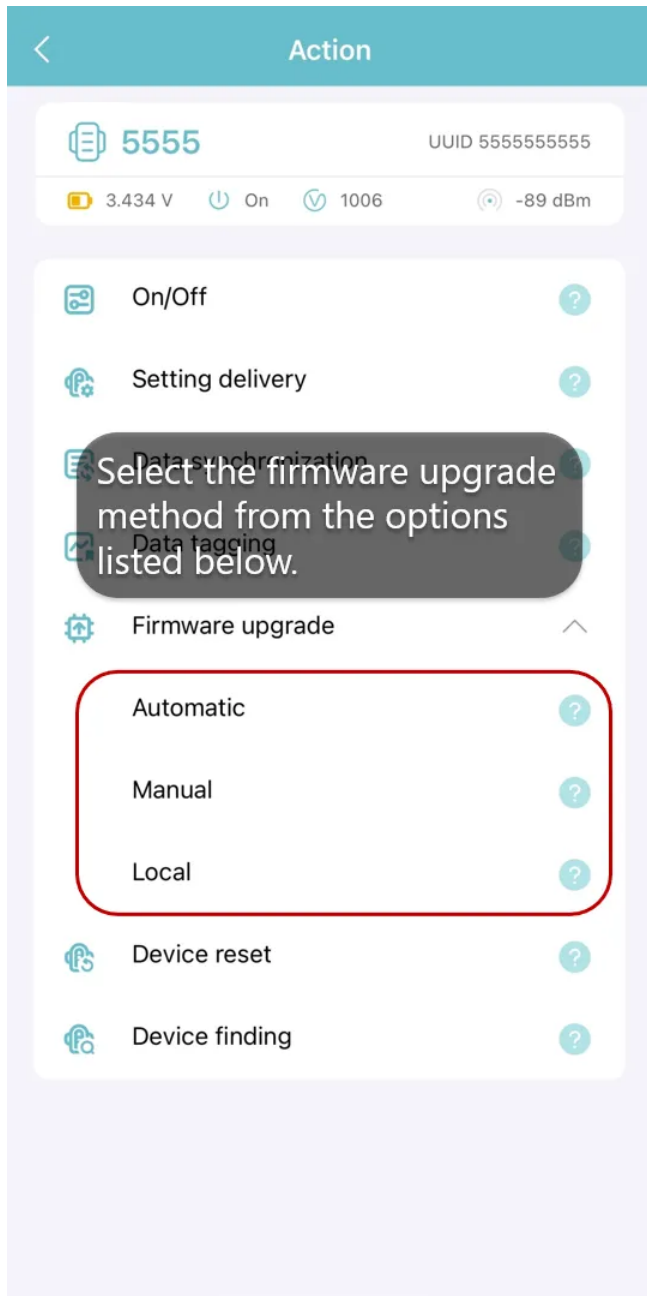

There are three options provided to select the firmware.

- Automatic

Use the latest firmware to upgrade your device. To avoid upgrade failure or device malfunction caused by the wrong version of the selected firmware, it is strongly recommended that you select the latest version to upgrade the firmware.

- Manual

Select the firmware manually from a list of available firmwares. This option is not available when multiple devices are selected.

- Local

Select the firmware from the local storage of your mobile. You must download the firmware

first. This option is not available when multiple devices are selected.

Step 5:

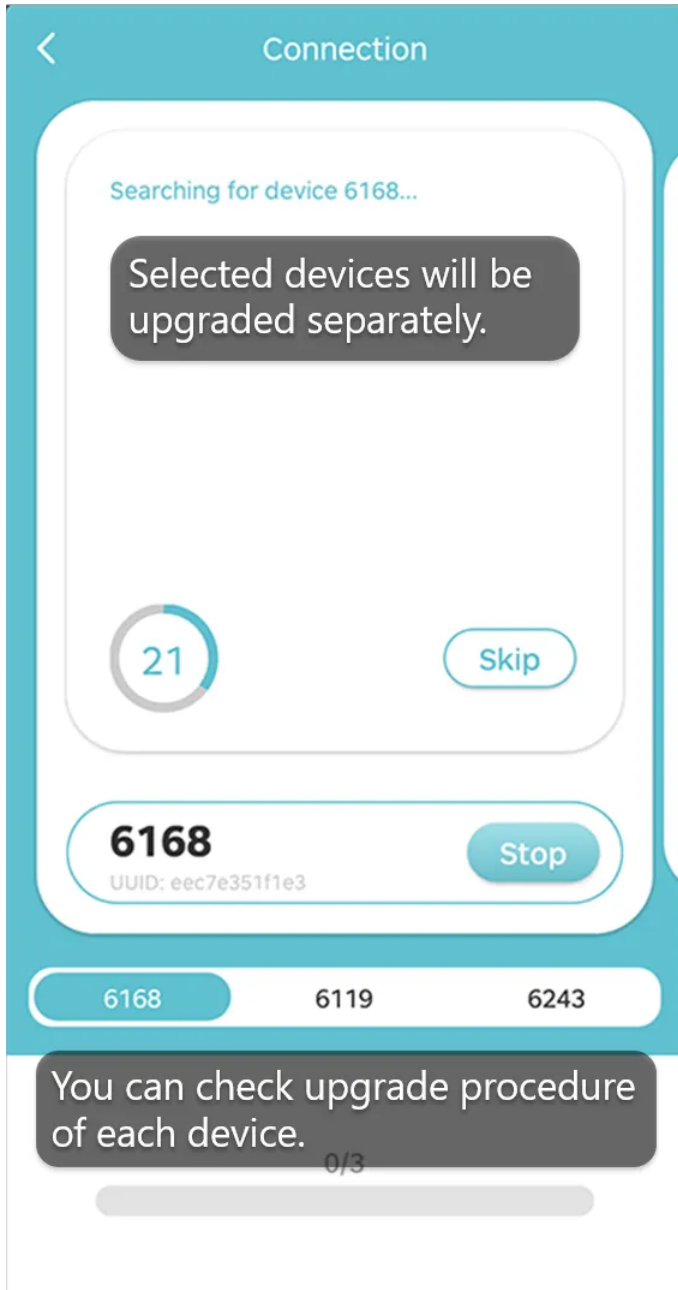

# Device Finding

This section gives the procedure to find your device. Before you start, make sure that you have turned on the Bluetooth on your mobile and your mobile is not muted.

### 1. Tap



icon at the bottom of the App.

App lists all of your devices. You can see the device number, MAC address and UUID of each device.



icon represents a gateway device, i.e. HUB.



icon represents a terminal device, i.e. FLEX, LEGO, MINI or NANO.

### 2. Select the device you need to download data.

You can identify the device by the MAC address printed on the back (for some devices, the last four digits of MAC address is printed). You can select **only one** device at a time.

### 3. In the pop-up menu, tap **Device finding**.

App starts searching for nearby devices and your mobile starts ringing. When you are getting closer to the device, the ring is getting louder.

## Using Relay Devices

When you want to perform INTELINK operations to a terminal device in Ecotopia App, the terminal device should be within the INTELINK range of your mobile phone. If it is not, you will need a relay device to extend the INTELINK range between your phone and the terminal device. A relay device can be a gateway (DEBUT HUB, DEBUT TAG G) or a DEBUT QUEST.

Before you start, make sure that both the terminal device and the gateway are under the same account or in the same group of Device Collaboration.

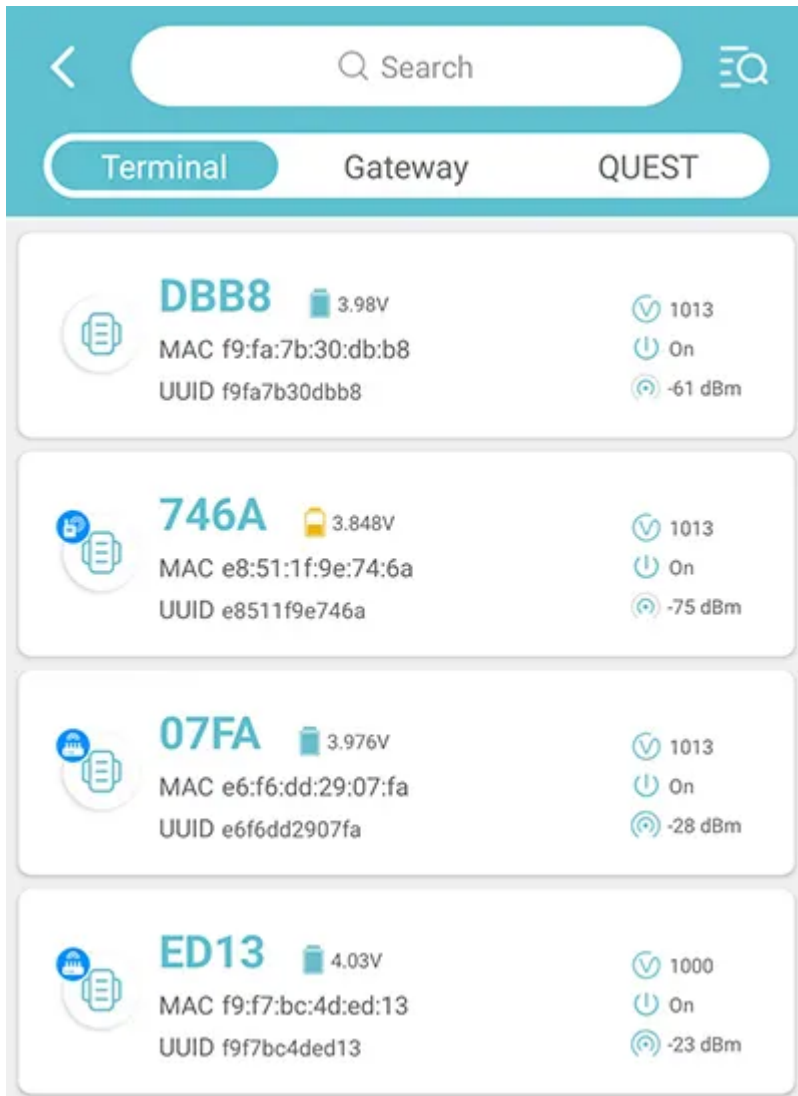

**Note:** QUEST doesn't need to be under the same account with the terminal device or in the same group of Device Collaboration.

1. Tap  icon on Ecotopia App to see all devices under the account or group.  
The devices are divided into three types, terminal, gateway and QUEST.



2. App will immediately begin to detect nearby terminal devices both directly and via the relay automatically at the same time.

Either way, the devices detected is in highlighted color while the devices not detected is in grey.

For a detected terminal device, a  icon indicates that the terminal device is detected by a gateway device, and a  icon indicates that the terminal device is detected by a QUEST.

3. Tap to select one terminal device, or tap and hold to select multiple devices for further INTELINK operations. The connection between App and the terminal device will be direct or via a relay as were in Step 2 accordingly.

Alternatively, you can tap **Gateway** or **QUEST** tab to view the available relay device. Select a relay and then tap **Nearby Terminals** to scan nearby terminal through the relay. A  icon indicates that App is connected to this relay and is detecting nearby devices through it.

Terminal Gateway QUEST

2C3D  
 MAC c5:5b:a1:1f:2c:3d  
 UUID c55ba11f2c3d

0161 3.959V 1005  
 MAC c0:2a:20:00:01:61 On  
 UUID 2a20000161 -48 dBm

No more data

Action

0211 UUID 2a20000211

Unknown Searching

- On/Off
- Setting delivery
- Data synchronization
- Firmware upgrade
- Device reset
- Device finding
- Nearby Terminals

## Device Reset

Device reset helps restore the device setting to factory setting, and clear unneeded history data stored in device memory (e.g., test data). You can perform this operation any time you want to have a fresh start of the device. This operation can be done when a device is either On or Off.

### Note

1. Factory setting is NOT the standard or recommended setting for each device model. You MUST perform [setting delivery](#) after device reset.
2. Reset is only supported on a device with the latest firmware. If you encounter an error message, please do [firmware upgrading](#).

Make sure that Bluetooth is enabled on your phone and authorized to Ecotopia App.

Step 1:

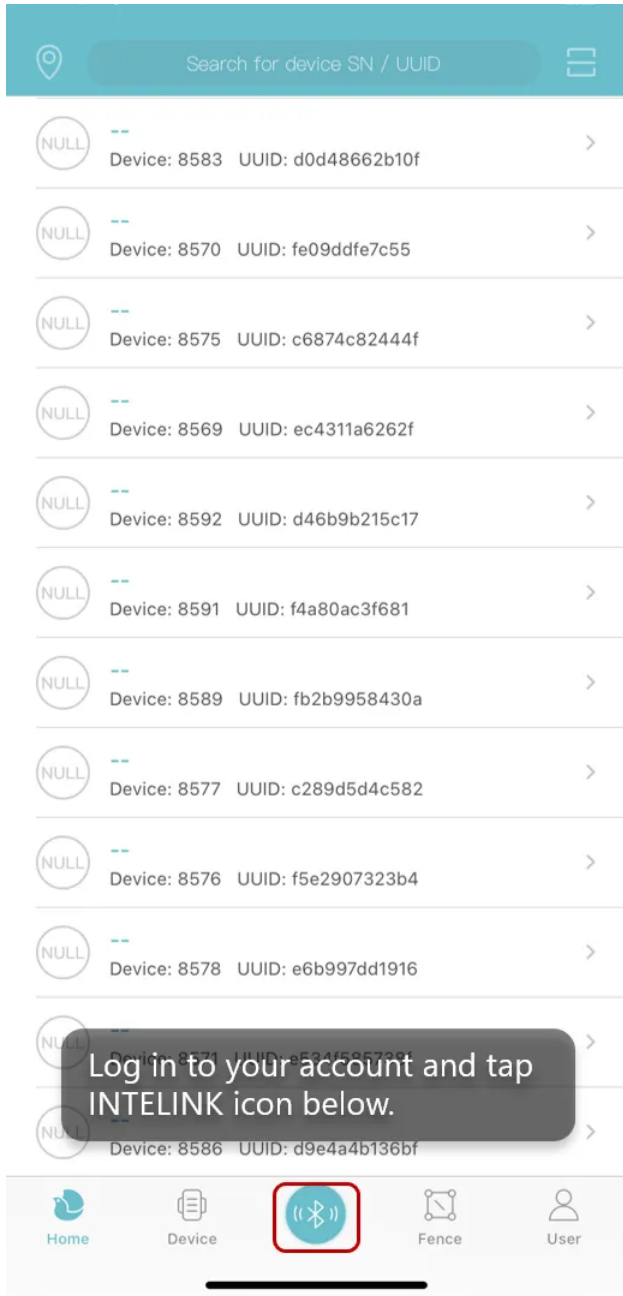

Step 2:





Step 3:

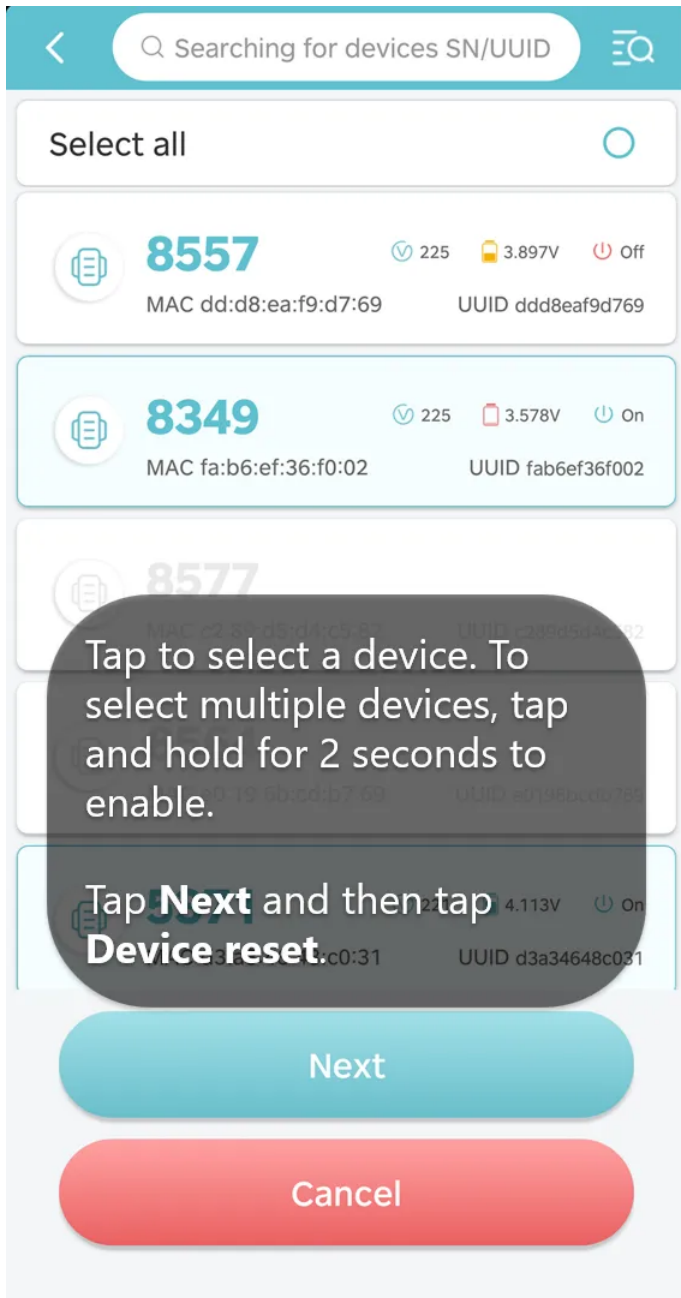

Step 4:



Reset



Default settings is applied after the reset. You can choose to erase the data from your device during the reset. The erased data cannot be restored.

Select whether to erase the data, and then tap **Reset**.

Erase device data

Reset

Device reset is done. You can also choose to turn on the device and delivery settings if necessary, following the instructions on the screen.

# Data Platform

This chapter contains operating instructions of Ecotopia Data Center and Ecotopia App. Click the links below to view the relevant content.

- [Ecotopia data center](#)
- [Ecotopia App](#)

## Ecotopia Data Center Instructions

Ecotopia data center online help contains the following topics:

- [Creating a Geo-fence](#)
- [Enabling Edge Intelligence](#)
- [New Billing Center](#)
- [Device Collaboration](#)
- [Displaying 2D Track in Heatmap Mode](#)
- [Sharing Data to Other Websites](#)
- [Changing BOOST Settings for a Terminal Device](#)
- [Highlighting the GNSS Track of a Day](#)
- [Changing Data Subscription Status](#)
- [ODBA Subscription](#)
- [Deleting GNSS Fixes](#)
- [Hiding / Showing GNSS Fix Icon](#)
- [Changing Settings for a Terminal Device](#)
- [Changing Settings for a Gateway Device](#)
- [Changing Settings for Multiple Devices](#)
- [Generating 3D Track](#)
- [Generating Multiple GNSS Tracks](#)
- [Downloading Data](#)
- [Adding Terminal to HUB](#)
- [Multiple Accounts Support](#)
- [Synchronizing Data to Movebank](#)

- [Terminology](#)

## Creating A Geo-fence

The procedure below to create a geo-fence on Ecotopia data center.

1. On the main menu, click **Geo-Fence**.
2. On the upper right of the page, click the **+** sign.
3. Edit the geo-fence.
  1. Enter the name for the geo-fence.
  2. Drag the map to the place where you would like to create your geo-fence.
  3. Choose the shape of the geo-fence.
  4. Draw your geo-fence on the map.

**Note:** If you plan to use the geo-fence as a trigger for Edge Intelligence feature, please keep the number of vertices in the geofence less than 10, otherwise the Edge Intelligence setting may not be delivered properly.
  5. Choose the notification trigger.

Note that **Enter** and **Exit** indicate that you will receive notifications when the device enters or exits the fence.
4. Click **Add Geofence** after you finish.
5. Close the map interface and refresh the page. You will see that you have successfully created a geofence. Click the number under the **Device** column to add devices to the geo-fence. After a device is added, you will receive notifications when the device enters or leaves the geo-fence.
  - The number of geo-fences that can be created is unlimited.
  - The number of devices that can be added to a geo-fence is unlimited.
  - A device can be added to unlimited number of geo-fences at the same time.





# New Billing Center

Compared with the old version, the new version of Billing Center adds the following content.

---

## More Detailed Billing Information

1. Click **Billing record** tab.
  2. Under **Detail** column, click **View**.  
You can check the billing quantity, unit price and total amount of each fee, and you can also click the number under **Device** to view all the devices that have incurred the fee.
- 

## Device Bill

1. Click **Device bill** tab.  
You can view the list of bills for each device
2. Click the Device ID to view the bill of the device by month. Click **View** under **Detail** column to view the various expenses incurred by the device in the current month.

# Enabling Edge Intelligence

Before you start, please confirm with your sales representative that the Edge Intelligence feature has been enabled for your Ecotopia account, you have downloaded the Ecotopia App, and upgraded the firmware of your DEBUT device above v1006.

1. Log in the Ecotopia Data Center on webpage. And choose the device you want to turn on the Edge Intelligence Setting.
2. Click **Device Setting** and then click **Advanced setting**.

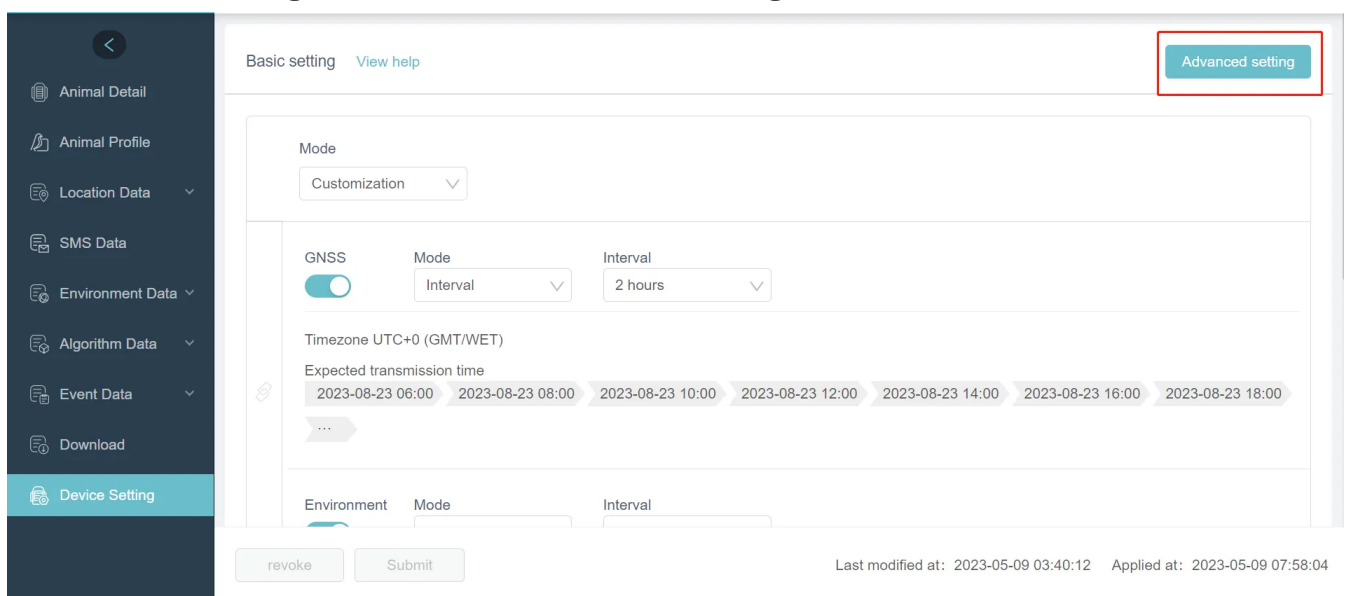

3. In the drop-down list, select **Edge Intelligence** and then click **Switch**.

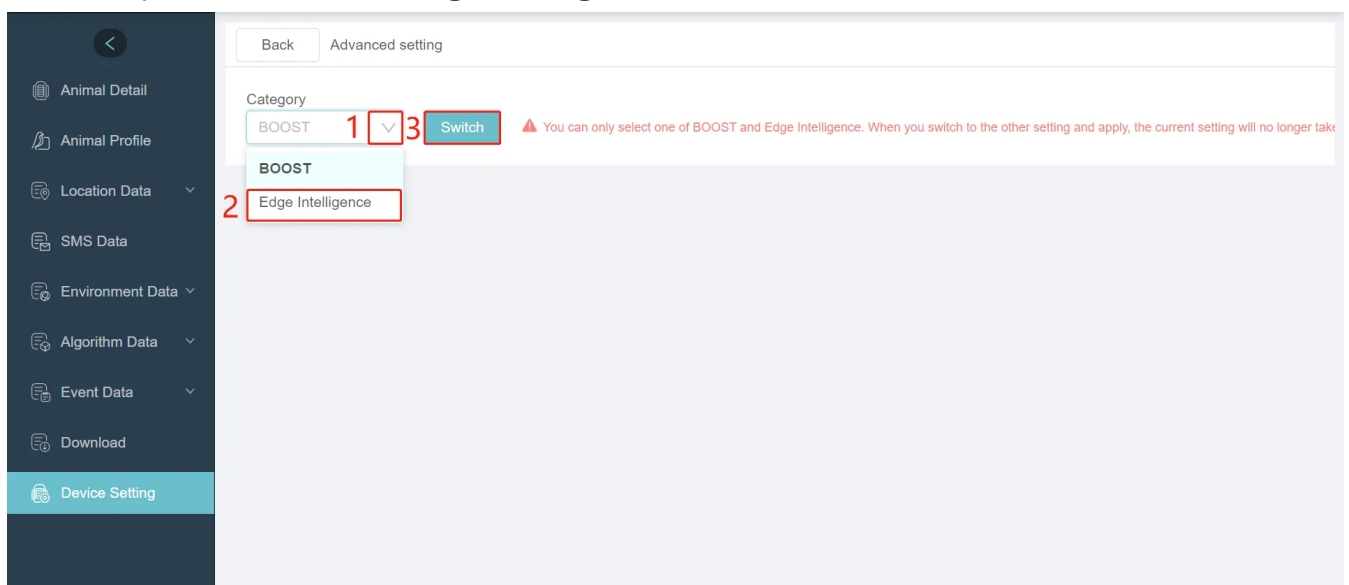

4. Turn on the Edge Intelligence and click **Confirm**.

5. Set the rules according to your needs and then click **New** to submit the rule. You can set multiple rules.

**Note:** if you are unsure how to set the conditions and actions in the rule, you can reach out to your sales representative and write to [support@druid.tech](mailto:support@druid.tech).

# Creating Collaboration Group

1. On the main menu, click **Collaboration**.

Data center displays the collaboration group page. Groups you have created or joined are listed here.

2. On the upper right of the page, click **New**.
3. Fill in the basic information of the group and then click **Next**.
4. Set the permission for this group. After you finish, click **Done**.

## Adding Member To The Group

After you created a group, you can add members to this group.

1. Go to the device list of the group by clicking the group name on the collaboration group page.
2. Click **Member List**.
3. On the upper right of the page, click **Add**.
4. Search for the member by the Ecotopia user ID.
5. Set the permission for the member. After you finish, click **Submit**.  
If you don't want to set a different permission for the member, click **Skip**. The added member will have the same permission as that of the group.

## Adding Device To The Group

After you created or joined a group, you can add devices to this group.

1. Go to the device list of the group by clicking the group name on the collaboration group page.
2. On the upper right of the page, click **Add device**.
3. Select the devices you want to add by checking the corresponding checkbox.
4. Click **Permission setting** to set the permission for the selected devices.  
Data center displays the permission of the group you have created or joined. By default, the permission of the added device is the same as that of the group. If you don't want to change it, click **Follow group permission**.  
If you need to set a different permission for the added devices, click **Customize device permission**.
5. Set the permission for the added devices.  
Skip this step if you select **Follow group permission** in step 4.
6. Click **Add**.

## Sharing Group

After you created a group, you can share the group to others.

1. Go to the device list of the group by clicking the group name on the collaboration group page.
2. On the upper right of the page, click  icon.
3. Set the validity period and then click **Copy link**.
4. Share the link with others who you want to add to the group.

**Note:** Anyone receives the link can join the group as long as they have a valid Ecotopia account. If the recipient opens the link with a mobile phone, they will be redirected to Ecotopia App. If they haven't installed the app, they will be prompted to download the app.

## Displaying 2d Track In Heatmap Mode

Before you start, make sure that you have generated a static track.

1. On the lower left of the track page, click .

2. In the pop-up box, select **Heatmap**.

The track is displayed in heatmap mode.

3. To change the heatmap setting, click  icon.

Heatmap setting window is displayed.

4. Make changes as needed and then click **Save**.

You can set the following items:

- **Gradient**  
Set the ratio of GNSS fixes and its corresponding color. Note that the value you enter is converted in percentage. Maximum value is 1.
- **Opacity**  
Visibility of the heatmap. 0 indicates that the heatmap is barely visible, while 100 indicates that the heatmap is fully visible.
- **Radius**  
Radius of heatmap. A higher value indicates that the heatmap will look bigger.



## Sharing Data To Other Websites

The content below gives the procedure to share the data of your device to other websites.

1. Log in to Ecotopia Data Center and click **Sharing > Websites** on the main menu.  
Data center displays a list of your previous sharing record. If you have shared any content yet, this page is blank.
2. On the top right corner of the page, click **New**.  
Data center displays sharing setting page.
3. Set the name of this sharing, set the expiration date and select a device.
4. Select the data you would like to share. You can share the following data:
  - Latest location  
The latest location of the animal. If the latest location has changed, the shared location on other websites changes as well.
  - Static  
The static track of the animal over a certain period of time.
  - Dynamic  
The dynamic track of the animal over a certain period of time.
5. Set the parameters for the selected data.  
For static track, you can set positioning type, transmission method, track type and time range.  
For dynamic track, you can set time range.
6. Set the map information.  
Select the map source, map layer and enter your map key.  
For Google, you can apply for the map key [here](#).  
For Mapbox, you can apply for the map key [here](#).
7. Set the layout.  
Layout determines the size and orientation of the shared content on other websites.
8. Click **Save**.  
After you finish, you can preview the generated content in the **Preview** window.  
**Note:** If the map key you entered is not correct, you will see an error page (Google Map) or a blank page (Mapbox) as shown below:  
Google Map

Preview



## Oops! Something went wrong.

This page didn't load Google Maps correctly. See the JavaScript console for technical details.







**Charadrius dubius**

Birdie

Gender	Age	Weight
Female	1	52



d9ae1ebdfee2 Serial number 2841 NANO

## Mapbox:

Preview



**Charadrius dubius**

Birdie

Gender	Age	Weight
Female	1	52



d9ae1ebdfee2 Serial number 2841 NANO

## 9. Click **Get link**

A window containing the generated link pops up.

10. Copy the link the paste it to the website.



















Example:

```
<!DOCTYPE html>
<html lang="en">
<head>
  <meta charset="UTF-8">
  <title>Title</title>
</head>
<body>
  ...
  <!--copy and paste the generated code here-->
  ...
</body>
</html>
```

**Note:** When you share the tracking route of an animal, e.g., a bird, its breeding location may be known to the public. Please kindly take poaching prevention into consideration and set it properly.



# Changing BOOST Settings For A Terminal Device

1. On the main menu, click **Device List** > **Terminal** and go to device list page.
2. Locate a device and click  icon.

Device ID	Updating status	Transmitting time	Model	Latest location	Label	Remark	Settings
7145	GPS ENV BHV	2022-01-26 08:32:02	MINI	-	A 特		  
0002	GPS ENV BHV	2021-11-30 11:05:54	NANO	-	A 特		  
2345	GPS ENV BHV	2021-11-23 07:21:11	MINI	-	A		  
000C	GPS ENV BHV	2021-11-22 10:49:21	MINI	-	哦 哦 产 9		  
77D6	GPS ENV BHV	2021-11-17 11:04:07	-	Sichuan, China	产	111	  
ABCD	GPS ENV BHV	2021-11-12 16:10:03	-	Guangdong Province, China	我 哦 哦 哦		  

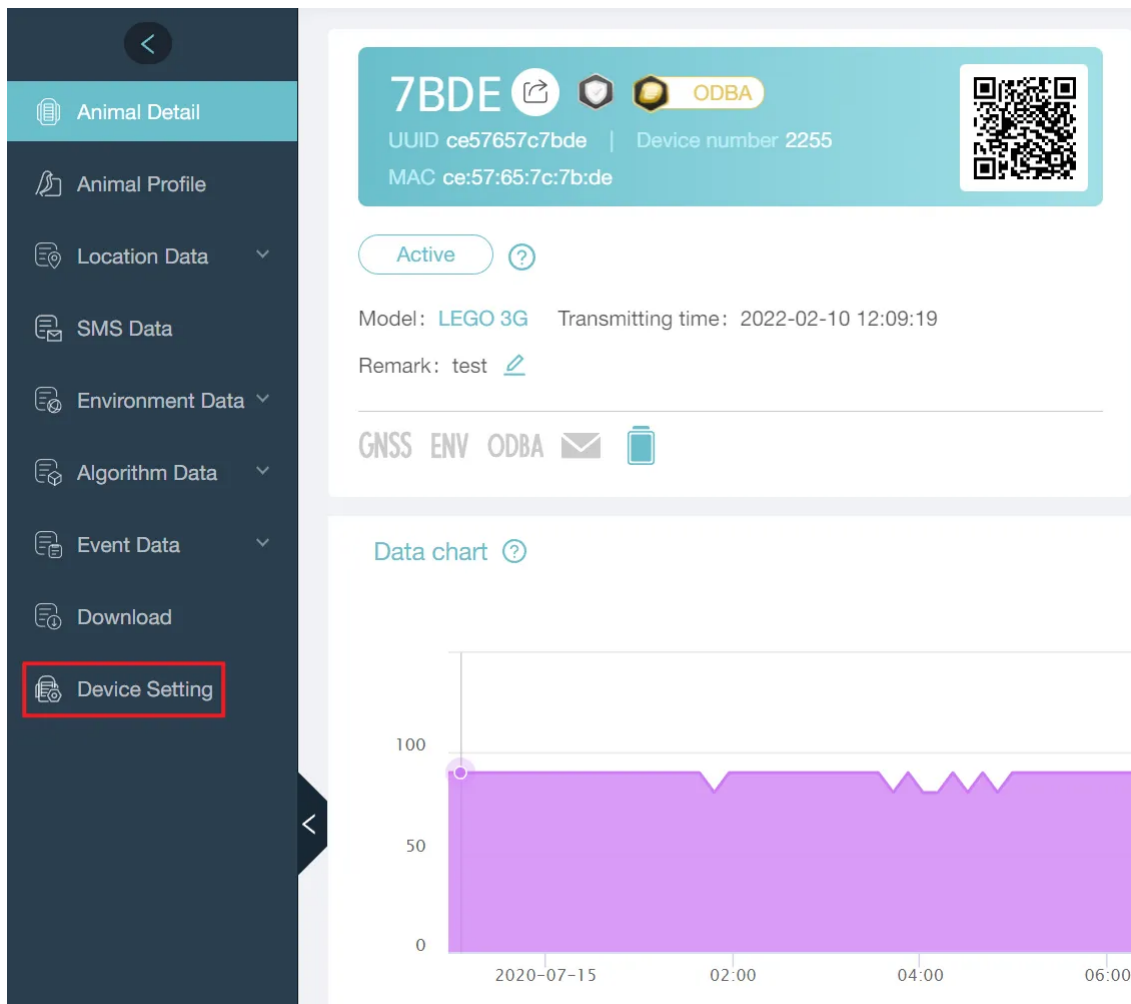
Or click a device to go to the device information page and then click **Device Setting** from the menu on the left.





**7BDE**    ODBA

UUID ce57657c7bde | Device number 2255  
MAC ce:57:65:7c:7b:de

**Active** 

Model: **LEGO 3G** Transmitting time: 2022-02-10 12:09:19  
Remark: test 

GNSS ENV ODBA  

Data chart 

100  
50  
0

2020-07-15 02:00 04:00 06:00

3. Click **Advanced setting** to go to BOOST setting page.

Basic setting [View help](#) Advanced setting

Mode  
Standard ▾

**GNSS**  Mode: Interval ▾ Interval: 1 hours ▾

**Environment**  Mode: Interval ▾ Interval: 1 hours ▾

**ODBA**  Mode: Interval ▾ Interval: 10 min ▾

**Cellular**  Mode: Interval ▾ Interval: 8 hours ▾  
This setting doesn't apply to devices that transmit data using INTELINK, Argos or Iridium

Click [here](#) for video instructions on BOOST setting.

# Highlighting The GNSS Track Of A Day

For any GNSS track that covers two or more days, you can highlight the part of a chosen day.

1. Generate a GNSS track that covers two or more days.
2. On the right panel, enable the **Track detail**.

After you enable the track detail feature, a side window slides out.

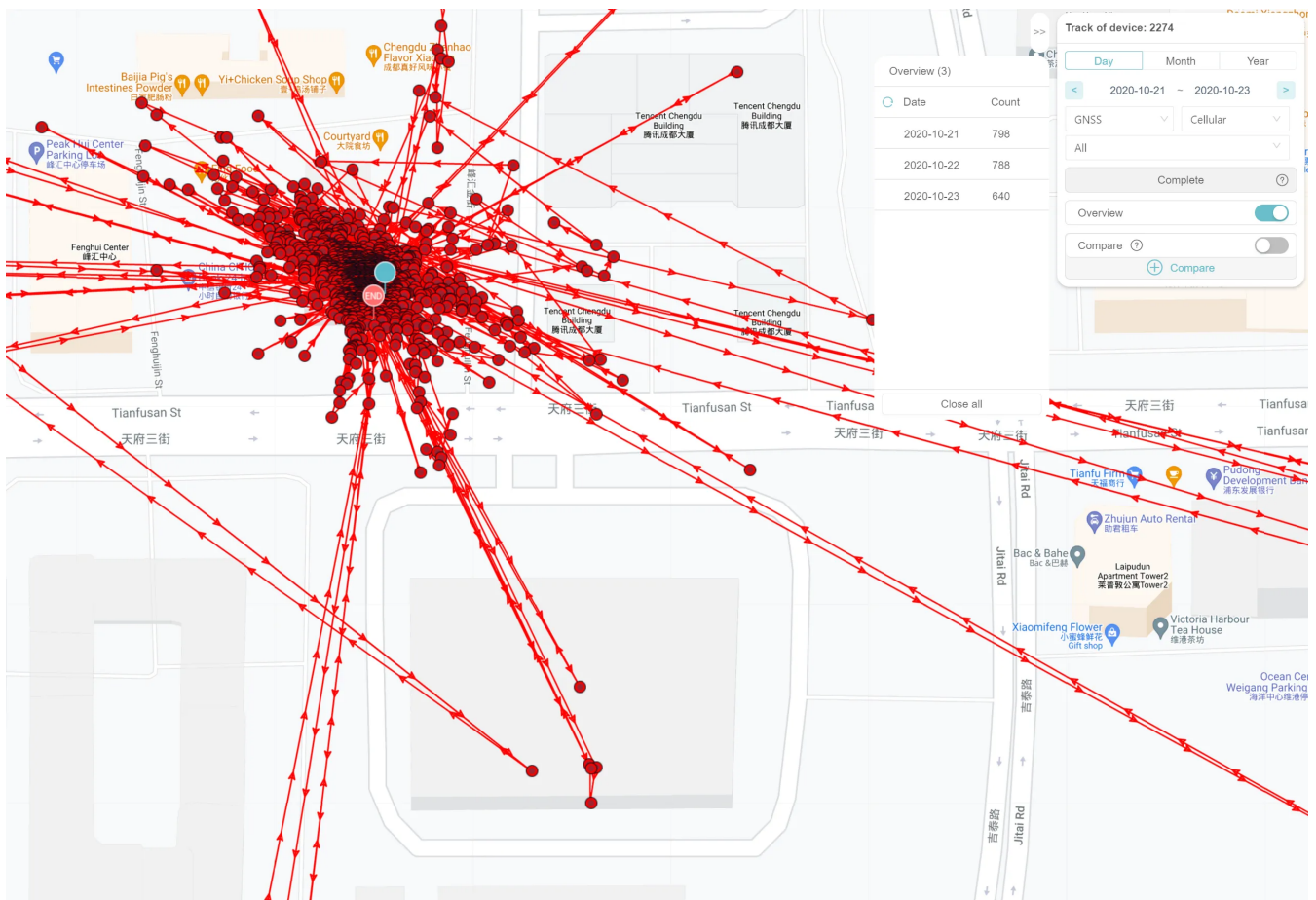

In the side window, you can see a list of GNSS fixes sorted by date.

3. Click the date as needed.

Data center displays the track of the selected date in a different color.

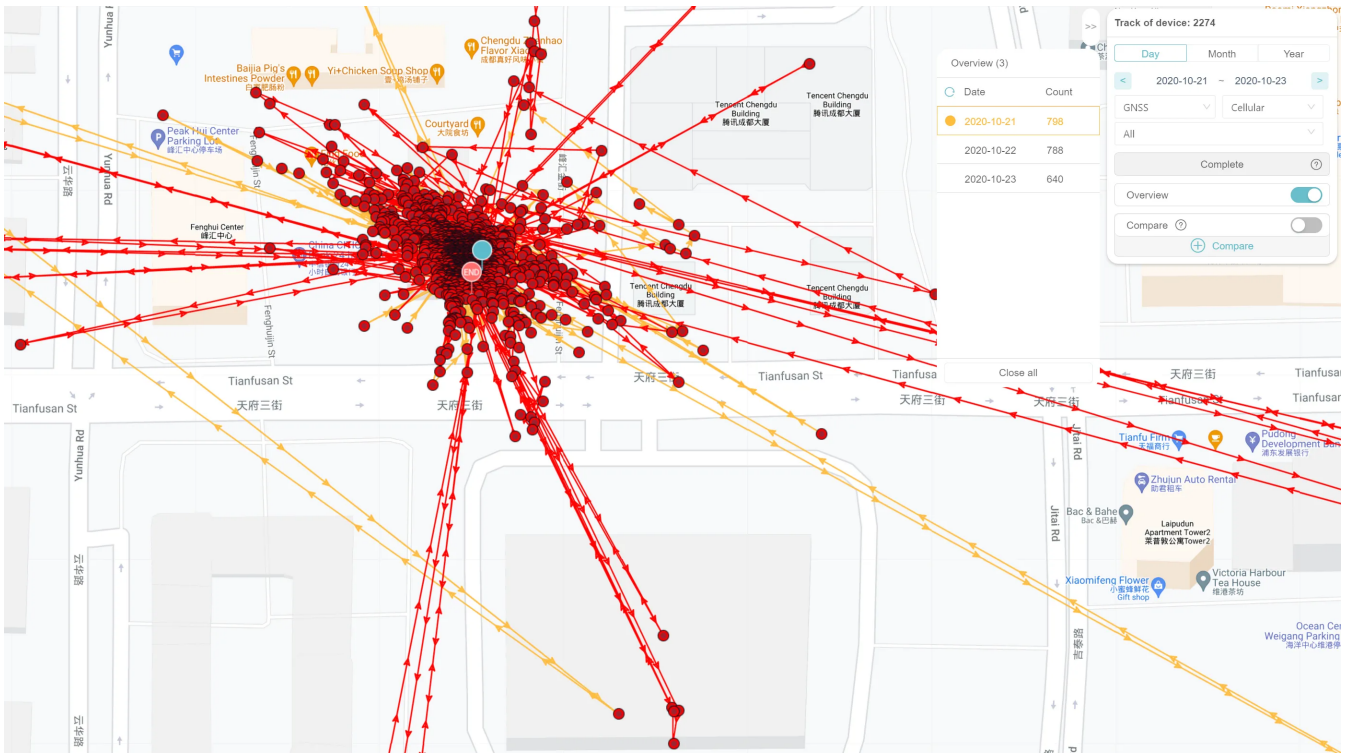

You can customize the highlight color by clicking the round color button.

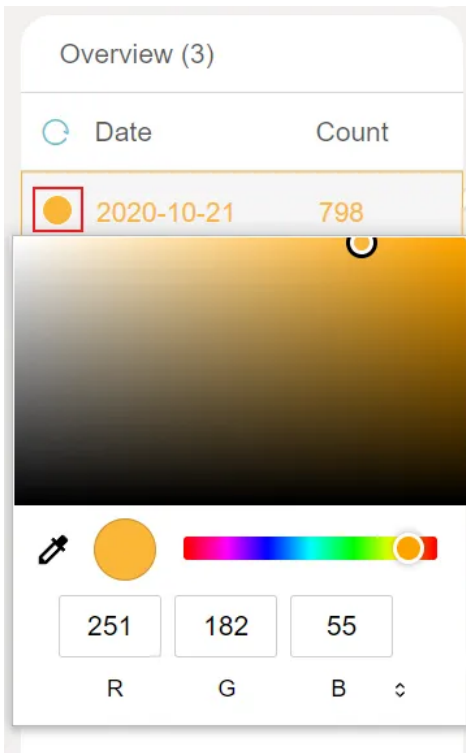

Alternatively, you can click on any of the GNSS fix, then enable **Highlight this day** feature.

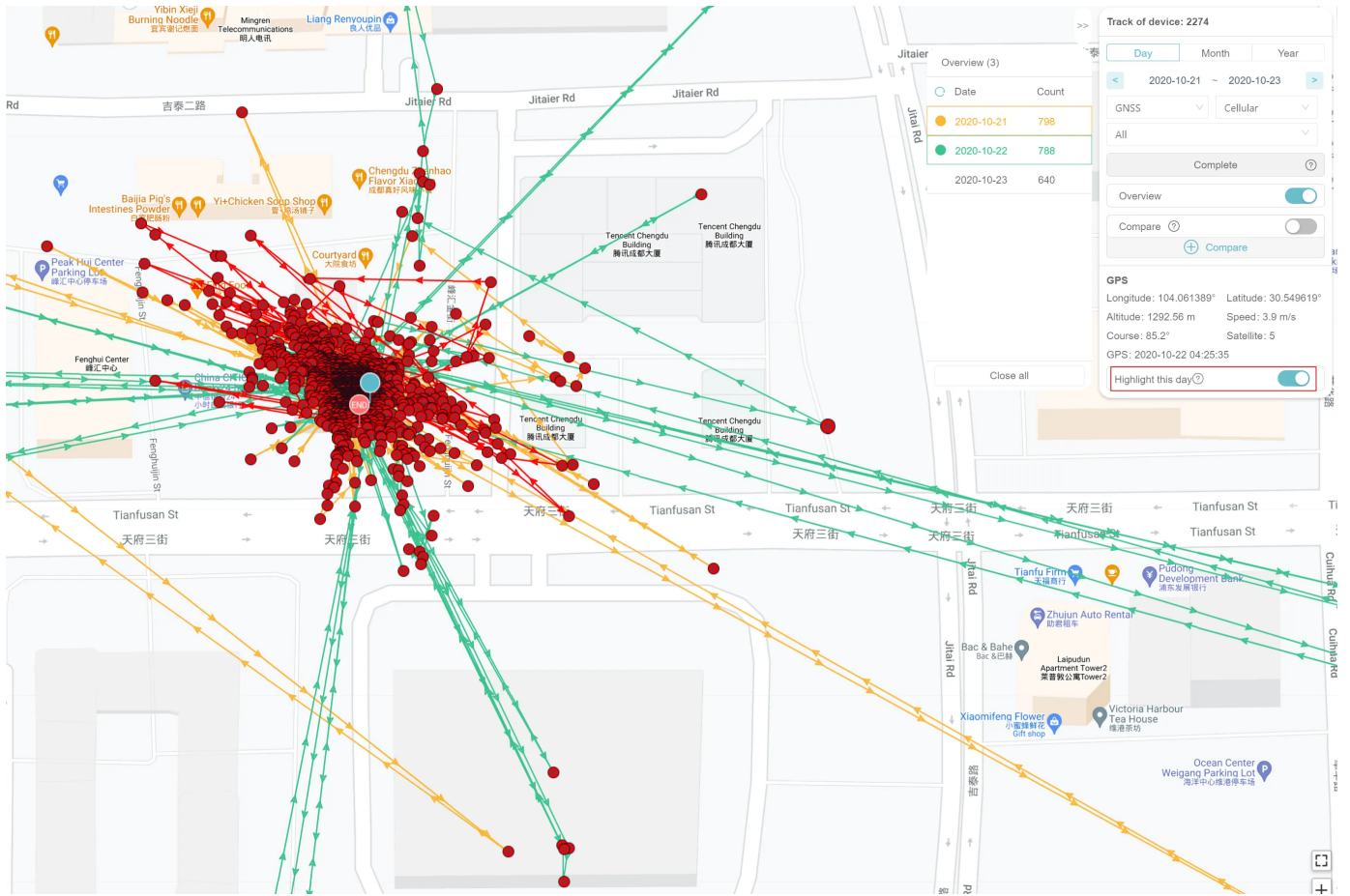

Data center highlights the track of the day when this GNSS fix is collected.



# Changing Data Subscription Status

## For a single device

1. On the main menu, click **Device List > Terminal**.  
Data center displays terminal list page.
2. On the terminal list page, click any terminal to go to the animal information page.  
You can see the current data subscription status of the device.

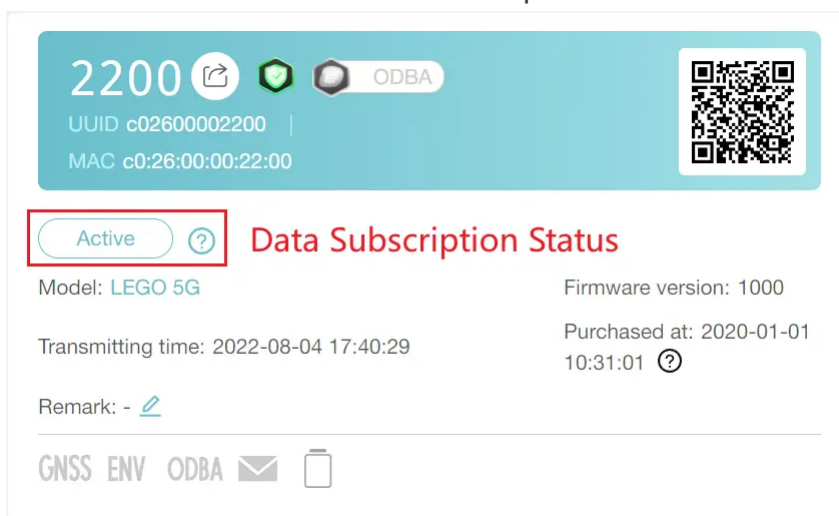

3. Click the status, and select a status in the pop-up list to change the status.

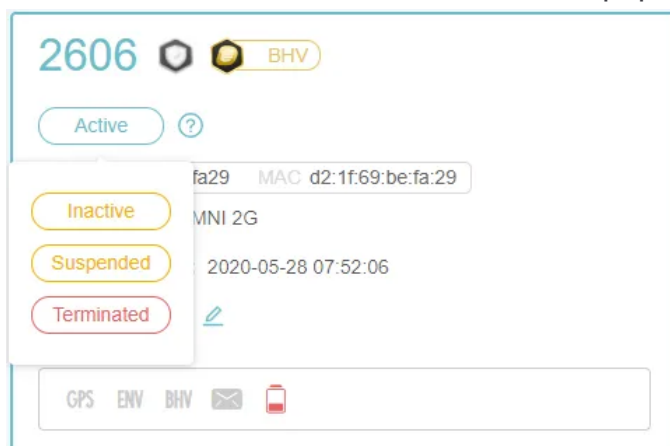

4. Follow the guidance to complete the operation.

## For multiple devices

1. On the main menu, click **Device List > Terminal**.  
Data center displays terminal list page.
2. On the upper right of the terminal list page, click **Change status**.

3. Select devices by checking the relevant checkbox.

4. On the top of the device list, click relevant status button to change the status.

**Note:** After you change the status, you must wait for at least 2 months before you can change it again. Different status will be charged differently. For more information, see [here](#).

# ODBA Subscription

## For a single device

1. On the main menu, click **Device List > Terminal**.  
Data center displays terminal list page.
2. On the terminal list page, click any terminal to go to the animal information page.  
You can see the status of ODBA subscription.

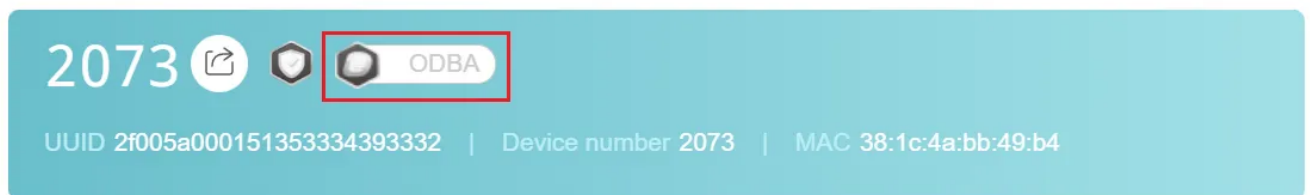

Active 

Device Name: FLEX Transmitting time: 2022-03-18 09:51:56

Remark: - 

---

GNSS ENV ODBA  

The gold icon indicates that the ODBA is subscribed. The gray icon indicates that the ODBA is not subscribed.

3. Click the icon to subscribe or unsubscribe ODBA.
4. Follow the guidance to complete the operation.

## For multiple devices

1. On the main menu, click **Device List > Terminal**.  
Data center displays terminal list page.
2. On the upper right of the terminal list page, click **Subscribe data**.
3. Select devices by checking the relevant checkbox.
4. On the top of the device list, click **Subscribe ODBA**.

**Note:** ODBA subscription is only applicable for **active** device. After you subscribe or unsubscribe ODBA, you must wait for at least 2 months before you can unsubscribe or subscribe it again.



## Deleting GNSS Fixes

There are various factors (click [here](#) to know more.) that can cause inaccurate GNSS positioning. After you generate a static track of a device, you can delete the GNSS fixes which are inaccurate according to your understanding.

This chapter gives the procedure to delete one or more GNSS fixes from a static track.

Before you start, make sure that you have generated a static track.

1. On the static track page, click  icon.

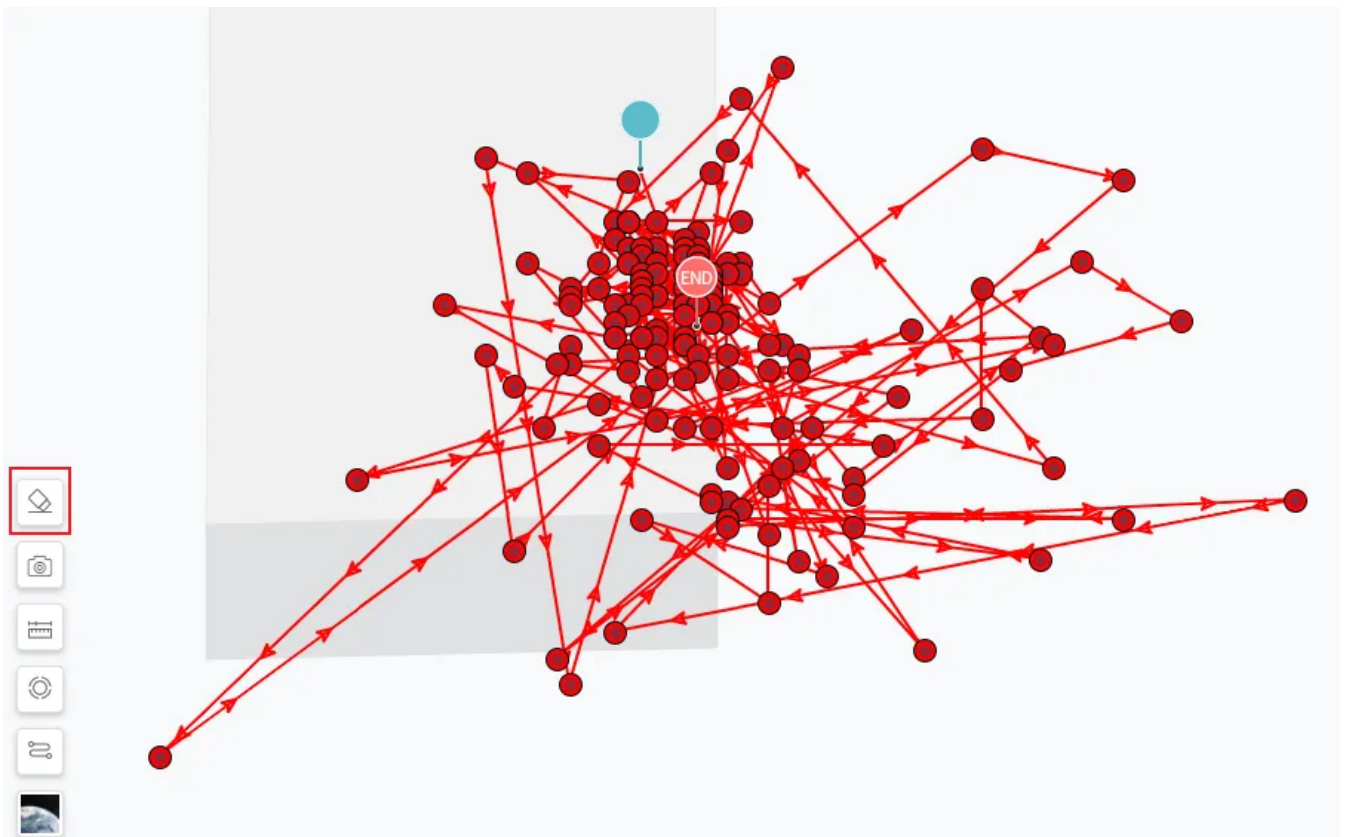

2. Click the GNSS fixes you want to delete.  
GNSS fixes that you clicked are displayed in grey.
3. Click **Save** after you finish.

Data center regenerates the static track.

If you would like to restore the deleted GNSS fixes, follow the procedure below:

1. Hover your cursor over the  icon.

A list that contains the deletion record pops up.

2. Click  icon on the list.

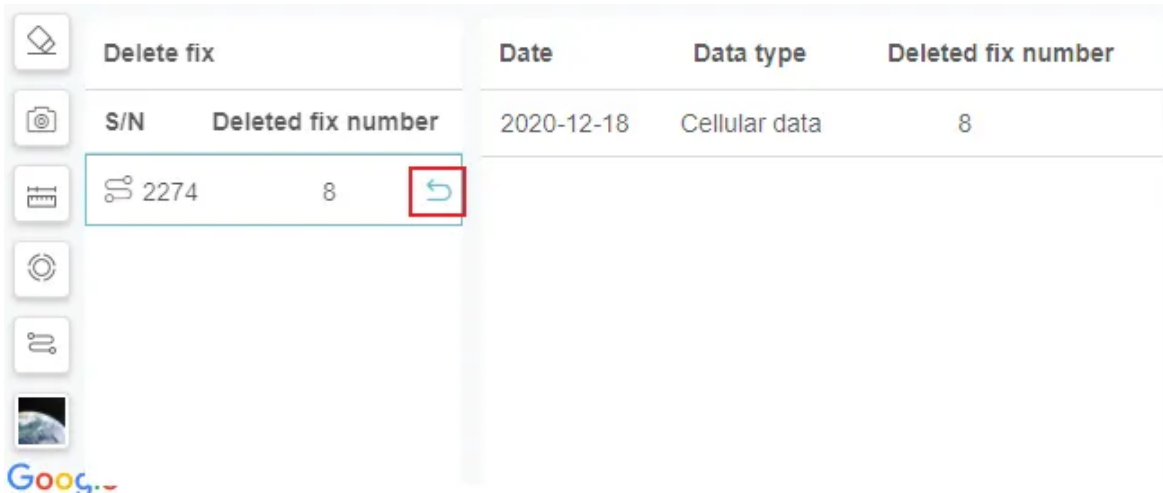

Delete fix		Date	Data type	Deleted fix number
S/N	Deleted fix number	2020-12-18	Cellular data	8
 2274	8			

3. Click **Restore** to restore the deleted GNSS fixes.

Data center regenerates the static track.

## Hiding / Showing GNSS Fix Icon

For computers with low performance, the track screen may get choppy or freeze when displaying a large number of GNSS fix icons. To solve this issue, you can click

 icon to hide the GNSS fix icon on the track page.

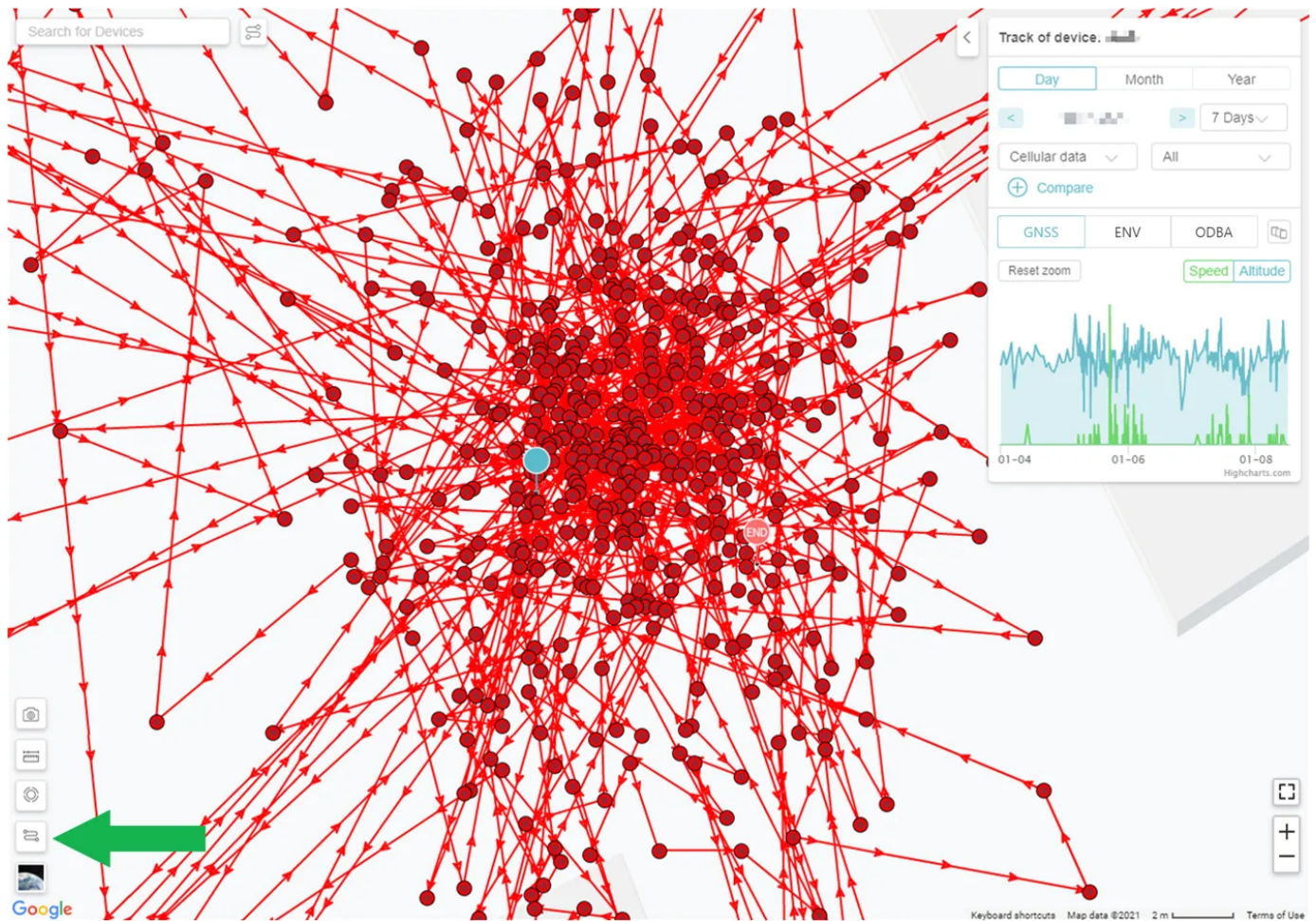

The graphic below shows a static track without GNSS fix icons:



Click the icon again to show the GNSS fix icons.















































# Changing Settings For A Terminal Device

You can change setting for a terminal device at device list page or the device information page.

## Changing setting at device list page

1. On the main menu, click **Device List > Terminal**.
2. Locate the device and click **Device setting** icon.

EDB8	 	30.5494432 °, 104.0596224 °	NANO Standard		  
331C	 	30.5496192 °, 104.0595648 °	NANO Standard		  
14BF	 	-	NANO Standard		  
242B	 	30.5497869 °, 104.0595497 °	LEGO 3G		  
1690	 	30.5496096 °, 104.0595648 °	Unknown model		  
0F61	 	-	LEGO 3G		  
024A	 	30.5497869 °, 104.0595497 °	LEGO 3G		  
C96E	 	30.5496640 °, 104.0596544 °	NANO Standard		  
02F9	 	30.5496096 °, 104.0595648 °	NANO Standard		  

3. Change the settings as needed.

For the detailed description on the terminologies on device setting page, see the [terminology](#) section.

4. Click **Confirm**.

## Changing setting at device information page

1. On the main menu, click **Device List > Terminal**.
2. Click device S/N to go to the device information page.
3. Click **Device setting**.

Terminals / Device Information : 2281

**2281** MINI  
UUID d527e62bf684

**Device setting** Applied at: 2020-04-08 09:40:56  
GPS 30 min ENV 30 min BHV 30 min Transmission 4 hours

**Animal profile**  
Species:- Gender:Female Age:Adult...

GUOJIAGOU 郭家沟

GPS ENV BHV ACC BSS SMS Hub Download

Select date Descending Track

Transmitting time	Collecting time	Longitude	Latitude	Altitude	Speed	Course	Satellit
2020-04-10 16:00:14	2020-04-10 15:59:30	104.0594176 °	30.5494688 °	681.88 m	0.4 m/s	276.3 °	9
2020-04-10 15:59:12	2020-04-10 15:29:01	104.0598208 °	30.549744 °	565.85 m	0 m/s	0 °	9
2020-04-10 15:59:12	2020-04-10 14:58:47	104.0594816 °	30.5502016 °	557.81 m	0.4 m/s	95.1 °	9
2020-04-10 15:59:12	2020-04-10 14:28:43	104.0596224 °	30.5497376 °	585.72 m	0.2 m/s	0 °	10
2020-04-10 15:59:12	2020-04-10 13:58:43	104.0595712 °	30.549744 °	579.34 m	4.3 m/s	202 °	9
2020-04-10 15:59:12	2020-04-10 13:28:32	104.0595008 °	30.5498656 °	552.99 m	0.5 m/s	106.6 °	9
2020-04-10 15:59:12	2020-04-10 12:58:34	104.0589952 °	30.5495136 °	578.3 m	3.3 m/s	190.2 °	7
2020-04-10 15:59:12	2020-04-10 12:28:33	104.0594496 °	30.5497216 °	531.95 m	2.9 m/s	140.9 °	9
2020-04-10 12:00:01	2020-04-10 11:58:33	104.059552 °	30.5501088 °	494.89 m	8.7 m/s	243.5 °	8
2020-04-10 11:59:52	2020-04-10 11:28:32	104.0597248 °	30.5496896 °	581.41 m	1.6 m/s	79.4 °	6
2020-04-10 11:59:52	2020-04-10 10:59:01	104.059648 °	30.549744 °	589 m	0.1 m/s	129.7 °	7
2020-04-10 11:59:52	2020-04-10 10:28:37	104.0593536 °	30.5499232 °	596.61 m	0.1 m/s	0 °	6

4. Change the settings as needed.

For the detailed description on the terminologies on device setting page, see the [terminology](#) section.

5. Click **Confirm**.

# Changing Settings For A Gateway Device

1. On the main menu, click **Device List > Gateway**.
2. Locate the device and click **Device detail** to go to the device information page.

S/N	Transmitting time	Voltage	SigStrength	Remark	Device detail
2508	2020-07-23 07:04:40	3.90 V	15 ASU	2508	Device detail
2608	2020-06-15 08:12:45	4.68 V	12 ASU		Device detail
2296	2020-05-20 01:49:30	4.34 V	31 ASU		<b>Device detail</b>
2335	2020-03-30 06:19:32	5.33 V	31 ASU		Device detail
2377	2020-03-09 08:32:51	5.22 V	22 ASU		Device detail
2412	2020-01-16 05:58:07	4.13 V	8 ASU		Device detail
2378	2019-12-19 07:31:56	4.13 V	22 ASU		Device detail
2351	2019-12-08 02:23:29	3.67 V	19 ASU		Device detail

3. On the left menu, click **Device setting**.

Terminals / Device Information : 2281

**2281** MINI  
UUID d527e62bf684

**Device setting** Applied at: 2020-04-08 09:40:56

GPS 30 min ENV 30 min BHV 30 min Transmission 4 hours

**Animal profile**

Species:- Gender:Female Age:Adult...

GUOJIAGOU  
郭家沟

GPS
ENV
BHV
ACC
BSS
SMS
Hub
Download

Descending
Track

Transmitting time	Collecting time	Longitude	Latitude	Altitude	Speed	Course	Satellite
2020-04-10 16:00:14	2020-04-10 15:59:30	104.0594176 °	30.5494688 °	681.88 m	0.4 m/s	276.3 °	9
2020-04-10 15:59:12	2020-04-10 15:29:01	104.0598208 °	30.549744 °	565.85 m	0 m/s	0 °	9
2020-04-10 15:59:12	2020-04-10 14:58:47	104.0594816 °	30.5502016 °	557.81 m	0.4 m/s	95.1 °	9
2020-04-10 15:59:12	2020-04-10 14:28:43	104.0596224 °	30.5497376 °	585.72 m	0.2 m/s	0 °	10
2020-04-10 15:59:12	2020-04-10 13:58:43	104.0595712 °	30.549744 °	579.34 m	4.3 m/s	202 °	9
2020-04-10 15:59:12	2020-04-10 13:28:32	104.0595008 °	30.5498656 °	552.99 m	0.5 m/s	106.6 °	9
2020-04-10 15:59:12	2020-04-10 12:58:34	104.0589952 °	30.5495136 °	578.3 m	3.3 m/s	190.2 °	7
2020-04-10 15:59:12	2020-04-10 12:28:33	104.0594496 °	30.5497216 °	531.95 m	2.9 m/s	140.9 °	9
2020-04-10 12:00:01	2020-04-10 11:58:33	104.059552 °	30.5501088 °	494.89 m	8.7 m/s	243.5 °	8
2020-04-10 11:59:52	2020-04-10 11:28:32	104.0597248 °	30.5496896 °	581.41 m	1.6 m/s	79.4 °	6
2020-04-10 11:59:52	2020-04-10 10:59:01	104.059648 °	30.549744 °	589 m	0.1 m/s	129.7 °	7
2020-04-10 11:59:52	2020-04-10 10:28:37	104.0593536 °	30.5499232 °	596.61 m	0.1 m/s	0 °	6

4. Change the settings as needed.

For the detailed description on the terminologies on device setting page, see the [terminology](#) section.

5. Click **Confirm**.

**Note:** You can only change the settings of data collecting and transmitting of the gateway itself.

# Changing Settings For Multiple Devices

1. On the main menu, click **Device Setting** to go to the device setting page.
2. Click **Change Setting**.
3. Select the devices by checking the checkbox.

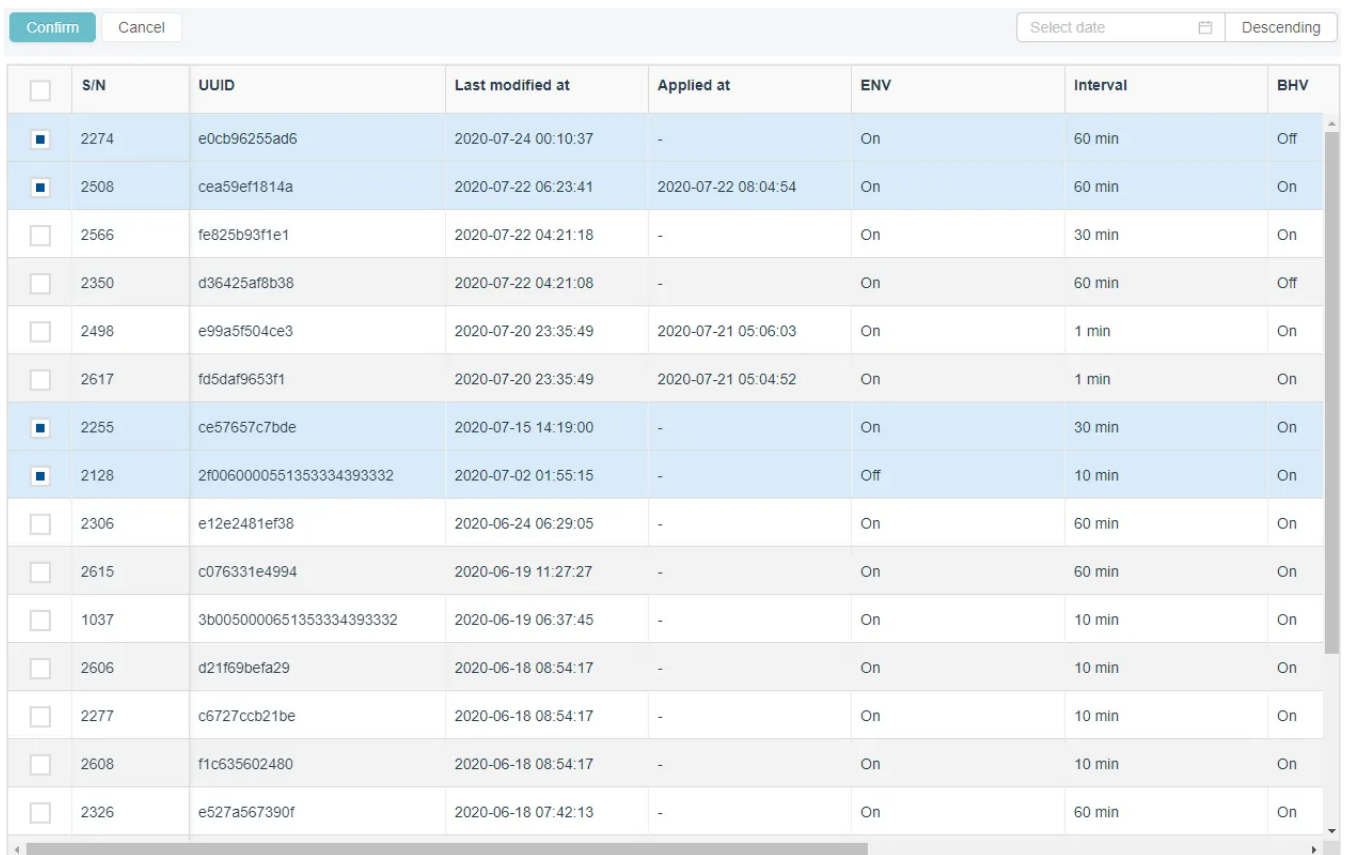

The screenshot shows a table with columns: S/N, UUID, Last modified at, Applied at, ENV, Interval, and BHV. There are 18 rows of data. The first two rows are highlighted in blue, indicating they are selected. The table has a 'Confirm' button at the top left and a 'Descending' sort option at the top right.

<input type="checkbox"/>	S/N	UUID	Last modified at	Applied at	ENV	Interval	BHV
<input checked="" type="checkbox"/>	2274	e0cb96255ad6	2020-07-24 00:10:37	-	On	60 min	Off
<input checked="" type="checkbox"/>	2508	cea59ef1814a	2020-07-22 06:23:41	2020-07-22 08:04:54	On	60 min	On
<input type="checkbox"/>	2566	fe825b93f1e1	2020-07-22 04:21:18	-	On	30 min	On
<input type="checkbox"/>	2350	d36425af8b38	2020-07-22 04:21:08	-	On	60 min	Off
<input type="checkbox"/>	2498	e99a5f504ce3	2020-07-20 23:35:49	2020-07-21 05:06:03	On	1 min	On
<input type="checkbox"/>	2617	fd5daf9653f1	2020-07-20 23:35:49	2020-07-21 05:04:52	On	1 min	On
<input checked="" type="checkbox"/>	2255	ce57657c7bde	2020-07-15 14:19:00	-	On	30 min	On
<input checked="" type="checkbox"/>	2128	2f0060000551353334393332	2020-07-02 01:55:15	-	Off	10 min	On
<input type="checkbox"/>	2306	e12e2481ef38	2020-06-24 06:29:05	-	On	60 min	On
<input type="checkbox"/>	2615	c076331e4994	2020-06-19 11:27:27	-	On	60 min	On
<input type="checkbox"/>	1037	3b0050000651353334393332	2020-06-19 06:37:45	-	On	10 min	On
<input type="checkbox"/>	2606	d21f69befa29	2020-06-18 08:54:17	-	On	10 min	On
<input type="checkbox"/>	2277	c6727ccb21be	2020-06-18 08:54:17	-	On	10 min	On
<input type="checkbox"/>	2608	f1c635602480	2020-06-18 08:54:17	-	On	10 min	On
<input type="checkbox"/>	2326	e527a567390f	2020-06-18 07:42:13	-	On	60 min	On

4. Click **Confirm**.
5. Change the settings as needed.

---

Device

---

Mode  RTL  STD  ECO  STB  OTT  CUT

Data type

GPS  On

ENV  On

BHV  On

Transmission  On

Time Interval

10 min

10 min

10 min

1 day

---

## Note

You can add more devices by clicking the **+** button.

For the detailed description on the terminologies on device setting page, see the [terminology](#) section.

6. Click **Save**.

# Generating 3d Track

Before you start, you must export the GNSS data in CSV format. For more information, see [data downloading](#) section.

1. On the main menu, click **Druid Earth > Dynamic (3D)**.

Data center opens a new window.

2. On the top right corner of the window, click  icon.

3. Click **Upload CSV file**.

Upload the GNSS data in CSV format from your local hard drive. When you complete, data center starts loading the dynamic track. The whole process may take up to 20 minutes, depending on the size of the CSV file. When the loading process is finished, data center will play the dynamic track automatically.

# Generating Multiple GNSS Tracks On The Same Map

1. On the main menu, click **Device List > Terminal**.
2. In the terminal list, click the SN of the device you want to view.
3. On the device information page, click **Track**.  
Ecotopia Data Center opens a new window to display the GNSS track of the device.
4. Click **Compare**.  
The track data is added to the compare panel.
5. In the search bar of the track page, enter the SN of the device you want to view.

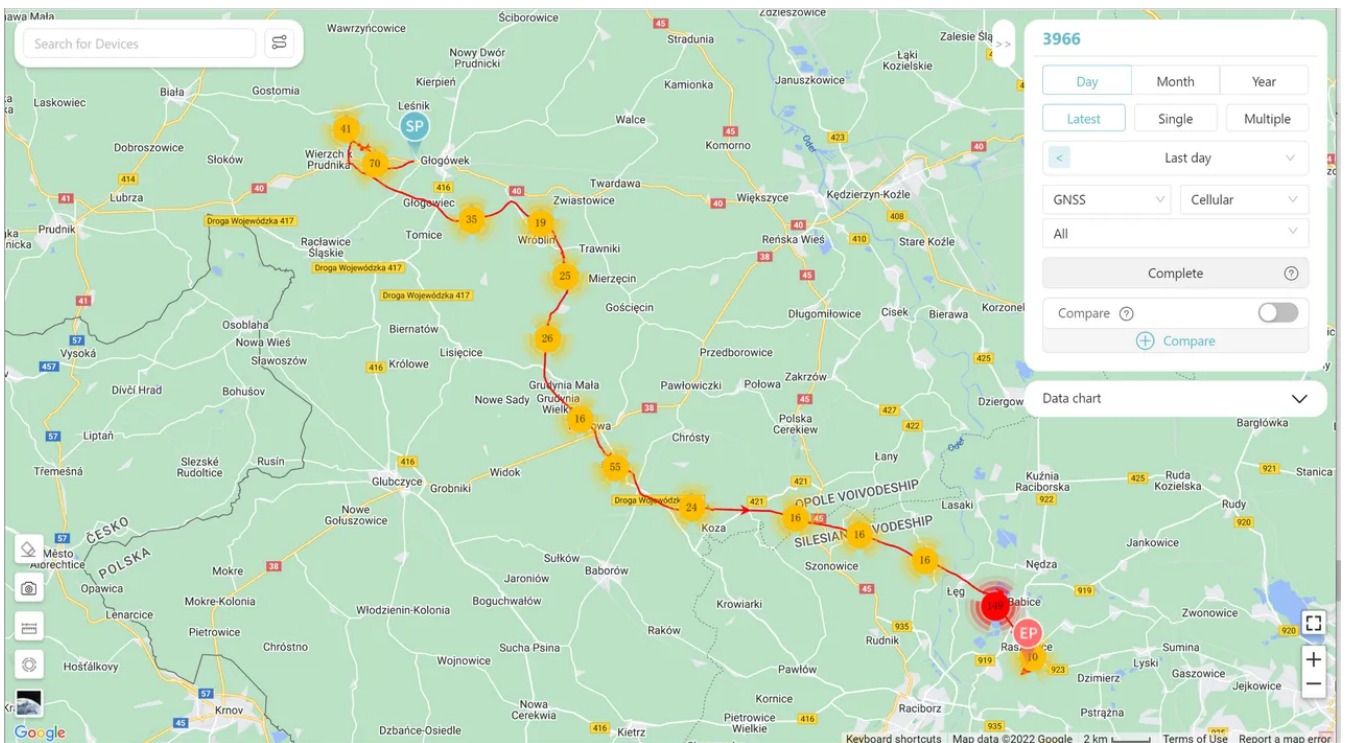

The search result is displayed in a drop-down list.

6. In the drop-down list, click the device.  
The GNSS track of that device is displayed on the map.
7. Click **Compare**.  
The track data is added to the compare panel.



8. On the compare panel, click the tracks.

Ecotopia data center displays the track of the two devices on the same map in a different color. You can add up to 5 devices.

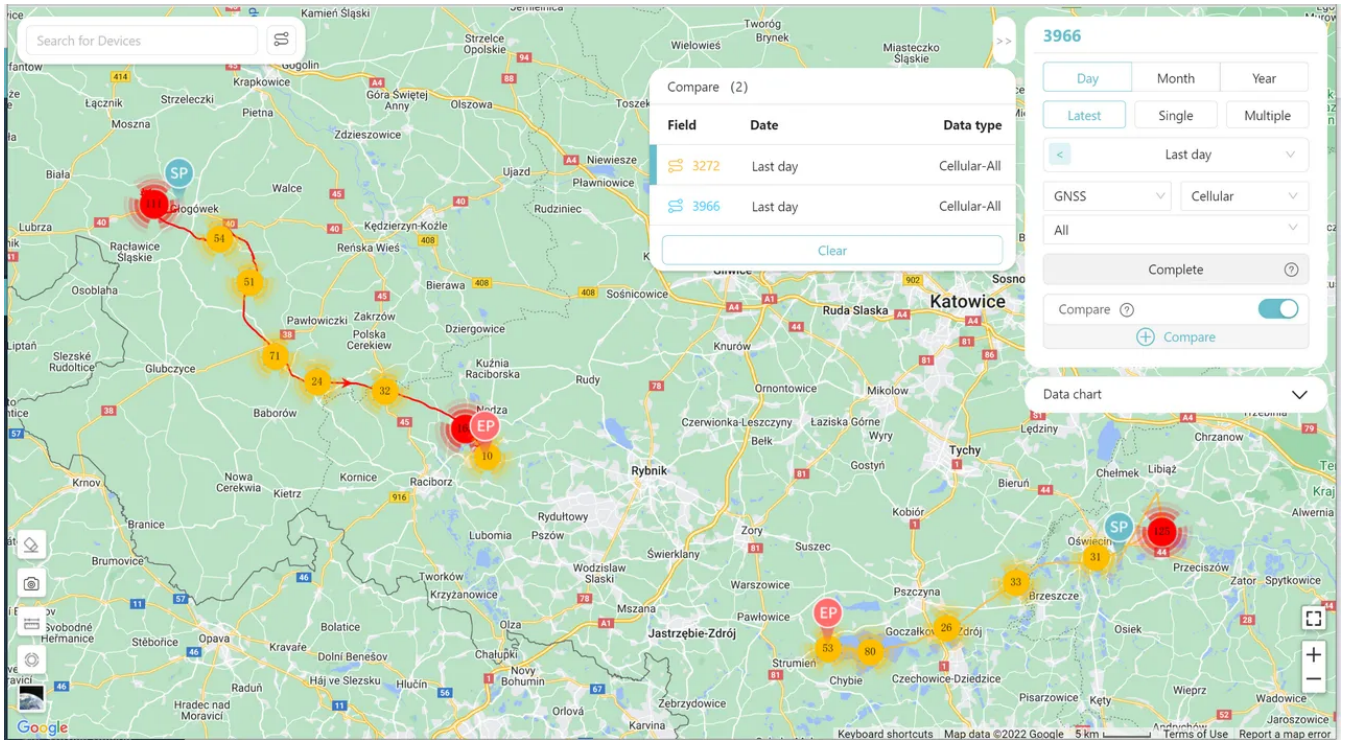

## Downloading Data

You can download the collected data to your laptop/computer for further analysis.

1. On the main menu, click **Download > Standard** to go to the standard download page.  
This page provides download link of the completed downloading tasks if any.

2. Click **Export data**.

3. In the device list, select one or more devices you need to download data.

4. Select the data type, data format and time range.

Note that KML format and GPX format are only available for GNSS data type. You can select any time range in months before the current time.

The screenshot shows the 'Data download' interface. At the top, there are filters for 'Data type' (set to GPS), 'Format' (set to .csv), and 'Time range' (set to Selected range(0)). Below the filters is a table with columns for S/N, Transmitting time, and Collecting time. Two rows are visible, representing data tasks for devices 2274 and 2328.

<input type="checkbox"/>	S/N		Transmitting time	Collecting time
<input checked="" type="checkbox"/>	2274	GPS ENV BHV	2020-08-13 09:02:29	2020-08-13 05:01:34
<input checked="" type="checkbox"/>	2328	GPS ENV BHV	2020-08-11 07:57:44	-

5. Click **Download**.

Data center starts preparing data in the background. You can see the progress on the page.  
Time required to prepare data depends on the data amount.

6. When the data is ready, locate the data in the list and click the download link to download it to your computer.

If you download data for multiple devices, you can search the device by the device number at the search bar.

Data center also provides you with the advanced downloading, which enables you to download data for any specified period, merge different data into one file, or specify the downloaded file name. To use the advanced downloading, click **Download > Customize**

**Note:** If you have downloaded the same data (meaning same device, same data type, and same time period), data center will not provide you with a new download link. You need to find the last download link in the download list to download the data. You can also go to the device details page, and then click **Download** on the left menu to enter the download list of the device to

download data.



If the device you selected did not collect the corresponding data, you will see a blank download link as shown below

Download link	File size	Data volume
-	-	0
-	-	0
-	-	0

For more information on the explanation of the fields in the downloaded CSV file, see [CSV field explanation](#)

## Adding Terminal To HUB

This section gives the procedure to add a terminal device to the whitelist of a gateway device. Before using INTELINK to connect to other terminal devices through a gateway device, you must add the terminal to the whitelist of the gateway device.

1. On the main menu, click **Device List > Gateway**.  
Data center displays the gateway list page.
2. On the right end of the related gateway, click  icon.  
Data center displays the white list page of the gateway.
3. On the upper right corner of the page, click  icon.  
Data center displays a list of available terminal devices.
4. Check the checkbox of the devices you want to add and then click **Confirm**.

**Note:** The white list information will be applied by the HUB in its upcoming transmission session or once you deliver settings to the HUB using the Ecotopia App. No action is required for terminal devices.

## Creating Account

You can create multiple sub-accounts in Ecotopia data center. Follow the procedure below to proceed.

1. On the main menu, click **Account Setup**.  
Data center displays account list page.
2. On the upper left corner of the page, click  icon.
3. In the pop-up window, fill in user information and then click **Confirm**.

Create account X

---

* Username	* Email
<input type="text"/>	<input type="text"/>
* Phone	* Address
<input type="text"/>	<input type="text"/>
* Password	* Confirm password
<input type="text"/>	<input type="text"/>

---

## Assigning Device

Follow the procedure below to assign devices to your sub-account.

1. On the main menu, click **Account Setup**.

Data center displays account list page.

2. Under the **Username** column, click the relevant username.

Data center displays account information page. The user profile field is shown as below:

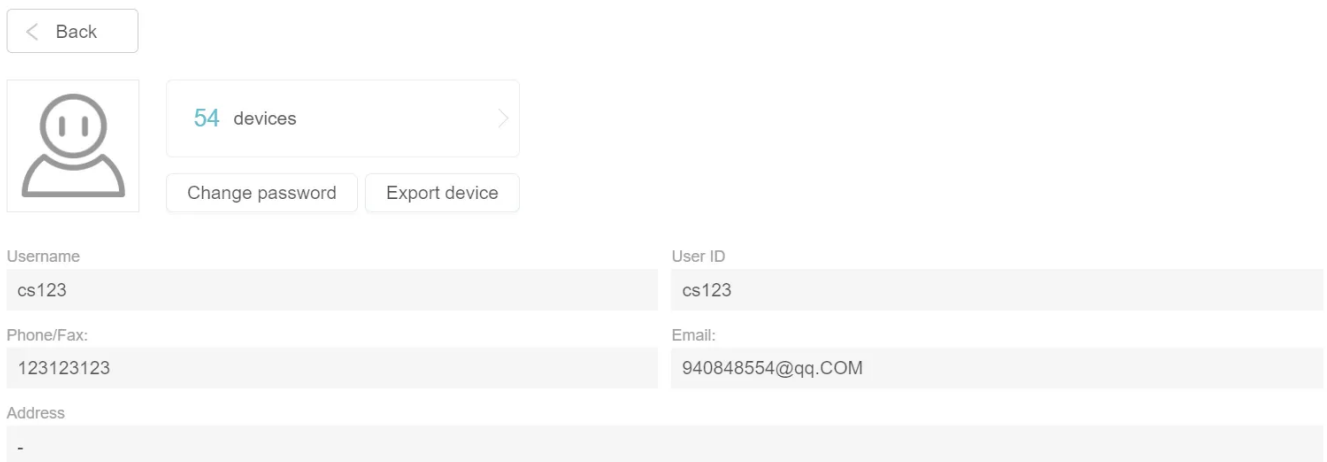

The screenshot shows a user profile page. At the top left is a '< Back' button. Below it is a user icon and a dropdown menu showing '54 devices'. To the right of the icon are two buttons: 'Change password' and 'Export device'. Below these are several fields for user information:

Username	cs123	User ID	cs123
Phone/Fax:	123123123	Email:	940848554@qq.COM
Address	-		

3. Click **xx devices** button.

**xx** is the number of device under this account. After you click the button, data center displays device list page.

4. On the upper right corner of the page, click  icon.

5. Check the checkboxes of the relevant device and the click **Add**.

# Permission Management

Follow the procedure below to set different editing or/and viewing permissions for the sub-account.

1. On the main menu, click **Account Setup**.

Data center displays account list page.

2. Under the **Username** column, click the relevant username.

Data center displays account information page. The permission setting field is shown as below:

Permission Setting [View help](#)

The screenshot displays the 'Permission Setting' interface. At the top, there is a 'Data Type' toggle switch which is turned on. Below this, the interface is organized into four columns, each representing a category of data with a 'View' label and a toggle switch. The categories and their items are:

- Basic Data:** GPS data, Environment data, Behavior data, SMS Data, BSS Data.
- Advanced Data:** Argos summary data, Argos location data, Iridium summary data, Iridium location data, BDS Data, Summary Data, Geo Data.
- Event Data:** HUB Data, Event Data, Proximity Data.
- Algorithm Data:** ACC raw data, Geomagnetic Data, Custom algo data.

Below the data type settings, there are two sections: 'Feature' and 'Others'. The 'Feature' section has a 'Switch' label and three items: 'Data download' (off), 'Data analysis' (on), and 'Map display' (on). The 'Others' section has 'View' and 'Edit' labels and four items: 'Animal Profile' (View off, Edit on), 'Device setting' (View off, Edit on), 'Personal profile' (View on, Edit on), and 'Geo-Fence' (View off, Edit on).

3. Modify the permissions of the account as needed.

For more information on each items of the permission, click **View help**.

## Removing Device

Follow the procedure below to remove devices from your sub-account.

1. On the main menu, click **Account Setup**.

Data center displays account list page.

2. Under the **Username** column, click the relevant username.

Data center displays account information page. The user profile field is shown as below:

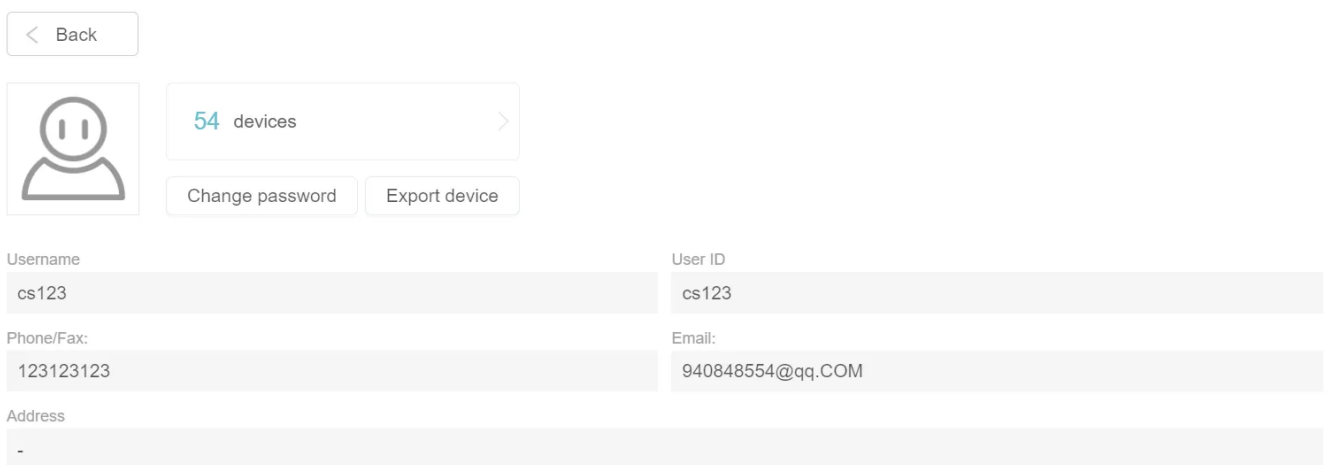

< Back

 54 devices >

Change password Export device

Username	cs123	User ID	cs123
Phone/Fax:	123123123	Email:	940848554@qq.COM
Address	-		

3. Click **xx devices** button.

**xx** is the number of device under this account. After you click the button, data center displays device list page.

4. On the right side of the list, click corner of the page, click  icon to remove the device.



## Synchronizing Data To Movebank

You can synchronize the data collected by Druid devices to your Movebank account.

1. On the main menu of Ecotopia datacenter, click **User Center > My Information**.
2. In the Movebank section, click **Add Account**.
3. Enter your Movebank username in the **Username** field and click **OK** after you finish.
4. Click the red box part and then click **Add device** to select devices of which the data needs to be synchronized to Movebank and click **Confirm**. Each time some devices are added to the Ecotopia account, **Add device** needs to be done for the newly added ones.

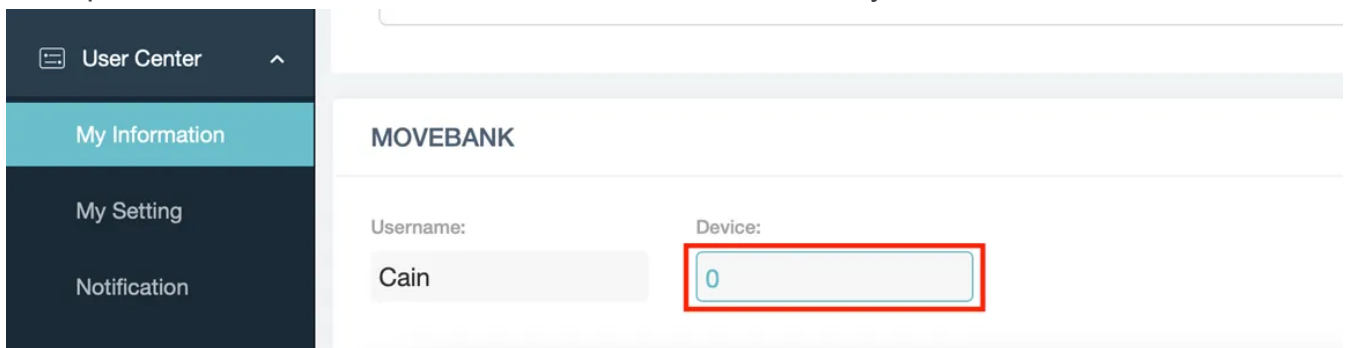

The screenshot shows a web interface for setting up a Movebank account. On the left, a dark sidebar has 'User Center' selected, with 'My Information' highlighted in teal. The main content area is titled 'MOVEBANK' and contains two input fields: 'Username' with the value 'Cain' and 'Device' with the value '0'. The 'Device' field is highlighted with a red border.

5. Wait for Ecotopia datacenter to automatically synchronize data to Movebank for the first time, which happens at 00:00 (UTC+0). Then click [here](#) for instructions on further settings on Movebank.

### Note:

- When you select your provider under Live Feeds in a Study in the Studies page on Movebank, please choose **Druid GSM** instead of **Druid Ecotopia**.
- After first-time Movebank setting, all history data will be synchronized to your Movebank account.
- You can choose to **Add Device** after Movebank setting. Then, all history data of the device will be synchronized to Movebank; You can also choose to **Remove Device** after Movebank setting. Then the data of the device that has been synchronized to Movebank will not be deleted.
- For some users, Data Points on Studies page on Movebank may show 0, which is just a display error you can just ignore.



## Terminology

- [CSV Field Explanation](#)
- [Setting Field Explanation](#)

# Csv Field Explanation

The table below gives the explanations to the data fields of the exported CSV data.

---

## gnss Data

Data field	Explanation
SN	Serial Number.
UUID	Universally Unique Identifier, a 128-bit number used to identify information in computer systems.
Transmitting time	Time the device communicates with the server, accurate to milliseconds.
Collecting time	Time the device collects data, accurate to seconds.
Longitude	Longitude of the GNSS fix in degrees, accurate to 7 decimal places.
Latitude	Latitude of the GNSS fix in degrees, accurate to 7 decimal places.
Altitude	Altitude of the GNSS fix in meters, accurate to 1 decimal places. It is calculated considering mean sea level.
Altitude (Ellipsoid)	Altitude (Ellipsoid) height of the GNSS fix in meters, accurate to 1 decimal place. It is calculated considering the ellipsoid.
Speed	Instantaneous speed of the device in m/s.
North Speed	The speed at which the device moves northward in the Local Tangent Plane Coordinates (LTPC), measured in m/s. When the value of the north speed is negative, it indicates that the device is moving southward.

Data field	Explanation
East Speed	The speed at which the device moves eastward in the Local Tangent Plane Coordinates (LTPC), measured in m/s. When the value of the east speed is negative, it indicates that the device is moving westward.
Down Speed	The speed at which the device moves downward in the Local Tangent Plane Coordinates (LTPC), measured in m/s. When the value of the down speed is negative, it indicates that the device is moving upward.
Course	The angle between the clockwise direction from the north and the movement direction of the device. The value range is 0 ~ 359.9, where 0 means the device moves towards north.
Satellite used	Number of satellites connected for positioning.
Positioning mode	Valid values are 0, 1, and 2, where 0 represents a failed positioning, 1 represents 2D positioning, 2 represents 3D positioning.
HorAccuracy	Index of horizontal accuracy of GNSS positioning. Lower value indicates that the positioning is more accurate.
VerAccuracy	Index of vertical accuracy of GNSS positioning. Lower value indicates that the positioning is more accurate.
HDOP	Index of horizontal accuracy of GNSS positioning. Lower value indicates that the positioning is more accurate.
VDOP	Index of vertical accuracy of GNSS positioning. Lower value indicates that the positioning is more accurate.
GNSS time consumption	Time spent in one positioning session in seconds.
Data Source	Modes of data collecting. Valid values are 1, 2, and 4, where 1 represents scheduled collecting, 2 represents dynamic collecting ( <a href="#">BOOST</a> data triggered by voltage), 4 represents in-flight collecting ( <a href="#">BOOST</a> data triggered by movement speed). There can be multiple values for Data Source.

Note: HorAccuracy and HDOP both indicate the horizontal accuracy of GNSS positioning. VerAccuracy and VDOP both indicate the vertical accuracy of GNSS positioning. Devices that support [INTELINK](#) (such as MINI, NANO, OMNI and some of LEGO) use HDOP and VDOP to indicate GNSS accuracy. Devices that do not support [INTELINK](#) (such as FLEX and some of

LEGO) use HorAccuracy and VerAccuracy to indicate GNSS accuracy. Each model will only use one type of these values. You can ignore another value type according to your device model.

---

## environment Data

Data field	Explanation
SN	Serial Number.
UUID	Universally Unique Identifier, a 128-bit number used to identify information in computer systems.
Transmitting time	Time the device communicates with the server, accurate to milliseconds.
Collecting time	Time the device collects data, accurate to seconds.
Temperature	Environment temperature in Celsius, accurate to 1 decimal place.
Light intensity	Light intensity in lx.
Voltage	Voltage of the device battery in volts, accurate to 3 decimal places.
Data Source	Modes of data collecting. Valid values are 1, 2, and 4, where 1 represents scheduled collecting, 2 represents dynamic collecting, 4 represents in-flight collecting.

---

## odba

Data field	Explanation
SN	Serial Number.
UUID	Universally Unique Identifier, a 128-bit number used to identify information in computer systems.
Transmitting time	Time the device communicates with the server, accurate to milliseconds.
Collecting time	Time the device collects data, accurate to seconds.

Data field	Explanation
ODBA	<a href="#">ODBA</a> value calculated by the device. A higher value indicates that the animal is more active.

## acceleration Data

Data field	Explanation
UUID	Universally Unique Identifier, a 128-bit number used to identify information in computer systems.
Transmitting time	Time the device communicates with the server, accurate to milliseconds.
Collecting time	Time the device collects data. If the sampling frequency is less than 1 Hz, the collecting time is accurate to seconds; if the sampling frequency is higher than 1 Hz, the collecting time is accurate to milliseconds.
X	Value of X-axis in 1/1024 g on the three-axis acceleration sensor.
Y	Value of Y-axis in 1/1024 g on the three-axis acceleration sensor.
Z	Value of Z-axis in 1/1024 g on the three-axis acceleration sensor.

**Note:** The measuring range of FLEX and some models of LEGO is -2 g ~ 2 g. The measuring range of MINI, NANO, OMNI and some models of LEGO is -4 g ~ 4 g.

## base Station Data

Data field	Explanation
SN	Serial Number.
UUID	Universally Unique Identifier, a 128-bit number used to identify information in computer systems.

Data field	Explanation
Transmitting time	Time the device communicates with the server, accurate to milliseconds.
Collecting time	Time the device collects data, accurate to seconds.
Longitude	Longitude of the BSS fix in degrees, accurate to 7 decimal places.
Latitude	Latitude of the BSS fix in degrees, accurate to 7 decimal places.
Accuracy	The accuracy of the estimated location, in meters. This represents the radius of a circle around the given location.
Base station used	Number of connected base stations in the positioning session.

## argos Location Data

Data field	Explanation
Transmitting time	Time the device communicates with the server, accurate to milliseconds.
Collecting time	Time the device collects data, accurate to seconds.
Longitude	Longitude of the Argos fix in degrees, accurate to 7 decimal places.
Latitude	Latitude of the Argos fix in degrees, accurate to 7 decimal places.
Altitude	Altitude of the Argos fix in meters.
Speed	Instantaneous speed of the device in m/s.

## argos Summary Data

Data field	Explanation
Transmitting	Time the device communicates with the server, accurate to milliseconds.



Data field	Explanation
time	
Collecting time	Time the device collects data, accurate to seconds.
Temperature	Environment temperature in Celsius, accurate to 1 decimal place.
Light intensity	Light intensity in lx.
Voltage	Voltage of the device battery in volts, accurate to 3 decimal places.
ODBA	<a href="#">ODBA</a> value calculated by the device. A higher value indicates that the animal is more active.

## intelink Summary Data

Data field	Explanation
Gateway UUID	UUID of the gateway that collects the data from the terminal.
Transmitting time	Time the gateway communicates with the server, accurate to milliseconds.
Collecting time	Time the gateway collects data from the terminal, accurate to seconds.
Voltage	Voltage of the terminal device battery in volts, accurate to 3 decimal places.
Temperature	Environment temperature of the terminal in Celsius, accurate to 1 decimal place.
Signal strength	Signal strength in dBm between the gateway and the terminal.
ODBA	<a href="#">ODBA</a> value calculated by the terminal. A higher value indicates that the animal is more active.

# Setting Field Explanation

This section gives the explanation to the setting fields on the device setting page.

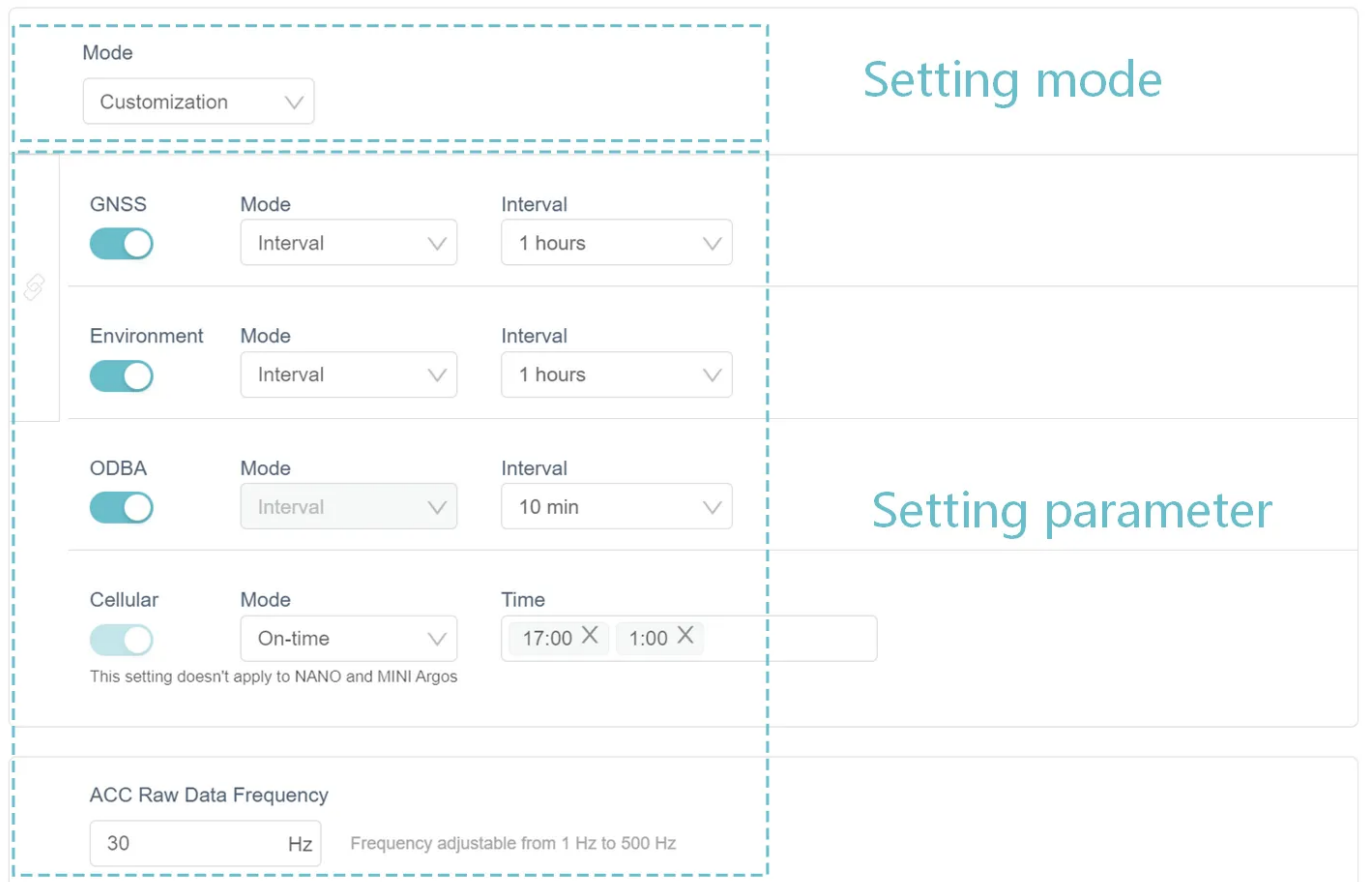

## Setting mode

### Real time mode

Interval of GNSS collecting, environment data collecting and ODBA collecting is 10 minutes. Interval of data transmission is 1 day. You cannot change the interval in this mode.

### Standard mode

STD mode is the default setting of DEBUT devices. Interval of GNSS collecting and environment data collecting is 4 hours. Interval of ODBA collecting is 10 minutes. Interval of data transmission is 8 hour. You cannot change the interval in this mode.

### Ecological—balanced

Interval of GNSS collecting and environment data collecting is 4 hours. ODBA collecting is turned

off. Interval of data transmission is 1 day. You cannot change the interval in this mode.

#### Stand-by mode

GNSS collecting, environment data collecting and ODBA collecting are turned off. Interval of data transmission is 1 day. You cannot change the interval in this mode.

#### Customized mode

In this mode, you can turn on or turn off GNSS collecting, environment data collecting and ODBA collecting and select the collecting interval and transmission interval as needed.

### **Setting parameter**

#### BOOST

Enable or disable BOOST.

#### GNSS data

Enable or disable GNSS data collecting. When enabled, you can set it to Interval mode or Follow transmission mode.

#### Environment data

Enable or disable environment data collecting. When enabled, you can set it to Interval mode or Follow transmission mode.

#### ODBA

Enable or disable ODBA collecting. When enabled, you can set the collecting interval to 10 min or 30 min.

#### Cellular

Enable or disable the cellular transmission. When enabled, you can set it to Interval mode or On-time mode.

#### Interval

The device transmits data to the server at a selected time interval.

#### Follow transmission

The interval of data collecting is synchronized with the transmitting interval of the device.

#### On-time

The device transmits data to the server at selected hour (based on the time zone set in the data center). You can specify up to 3 time options per day.

## ACC Raw Data Frequency

Set the data collecting frequency of acceleration raw data

On this page >

---

---

## Ecotopia App Instructions

Ecotopia App online help contains the following topics:

- [Platform and Account](#)
- [Publishing a Quest](#)
- [Accepting a Quest](#)
- [Sharing Your Animal](#)
- [Changing Data Subscription Status](#)
- [Adding Terminal to HUB](#)
- [ODBA Subscription](#)
- [Changing Device Setting](#)
- [Cache Management](#)
- [Firmware Management](#)

## Platform And Account

You can add more than one platform and account to your app so that you can switch among different platforms and accounts as needed. You can also edit the platform information, or share the platform to other users.

Click the instructions below to proceed.

- [Sharing\\_platform](#)
- [Adding\\_platform](#)
- [Adding\\_account](#)

## Sharing Platform

1. On the login page, click the small down arrow.

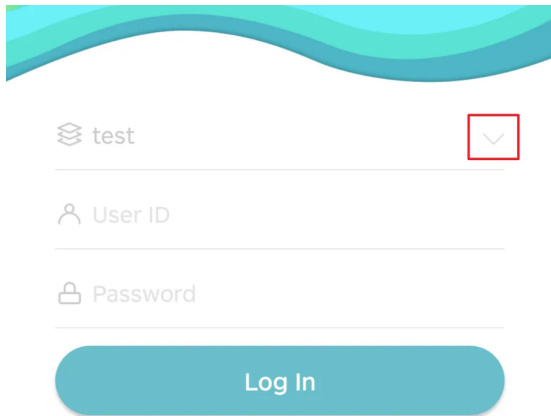

2. Click **Editor** then click the



icon.

3. Choose how would you like to share the platform.

We recommend that you share the platform using QR code, which is more convenient for other users to add the shared platform.

[Back](#)

## Adding Platform

1. On the login page, click the small down arrow.

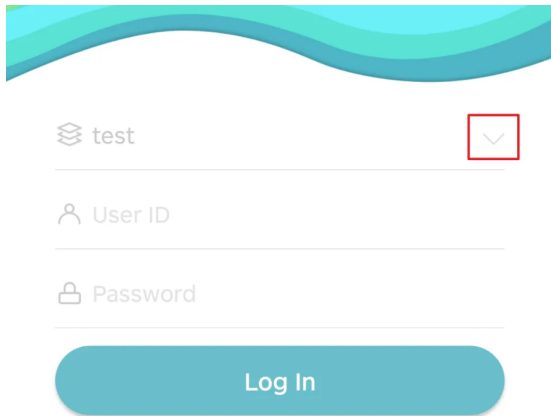

Alternatively, you can log in to your account, and tap **User > Platform and Account**.

2. Click **Add platform**.

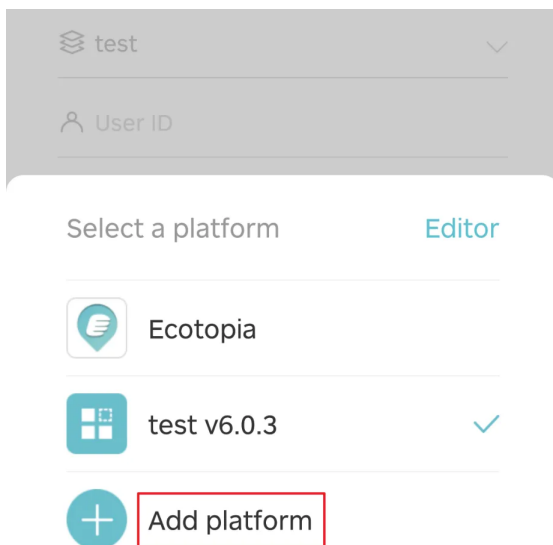

3. Scan the QR code of the platform.

The QR code can be shared by anyone who can access the platform.

After you scan the QR code, you can see the platform information shown as below.



Platform name  
test

Server address  
https://bird.coolhei.com

Device address  
api.coolhei.com:9010

Client ID  
1

Authentication

4. Click **Authenticate**, and then click **Add** to add the platform.

[Back](#)

## Adding Account

1. Log in to your account, and tap **User > Platform and Account**.

You will see a list of platforms.

2. Click the



icon of a platform.

You will start adding user to the selected platform.

3. Enter the user ID and password and then click **Save**.

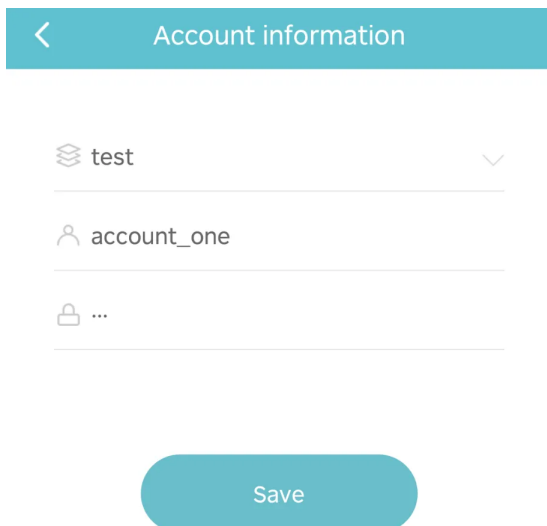
A screenshot of a mobile application's 'Account information' form. The form has a teal header bar with a back arrow and the text 'Account information'. Below the header, there are three input fields. The first field has a platform icon and the text 'test'. The second field has a person icon and the text 'account\_one'. The third field has a lock icon and three dots. At the bottom of the form is a large teal button with the text 'Save'.

App will verify the account information after you tap **Save**. If the account information is not correct, or the account does not exist, the authentication fails. However, you can still save the incorrect account information to your app.

Account with incorrect information is displayed with





icon.

< Platform and Account

 Ecotopia 

 test 

 abc    
成都德魯伊科技有限公司

 account\_one 

 Add platform

[Back](#)

## Publishing A Quest

When a deployed animal is far away from the INTELINK range of your gateway, or somewhere without internet coverage or satellite signal, you can publish a quest via IntelinkGO so that other IntelinkGO users can accept the quest and help you synchronize data from the device.

Make sure that you have installed and logged in to IntelinkGO on your mobile.

1. Launch Ecotopia App and go to device information page of the device.
2. On the top right of the page, tap **Quest**.

App displays quest editing page. You can edit the following information:

- Animal location

Tap **Edit** on the map to edit the possible range of the animal's whererabout.



- Expiration date

Set the expiration of this quest.

3. Tap **Publish to IntelinkGO**.

IntelinkGO is launched automatically. If you haven't installed IntelinkGO, you will be redirected to Google Play or App Store to install the App.

4. In IntelinkGO, you will see a pop-up message. In the pop-up window, tap **Post**.

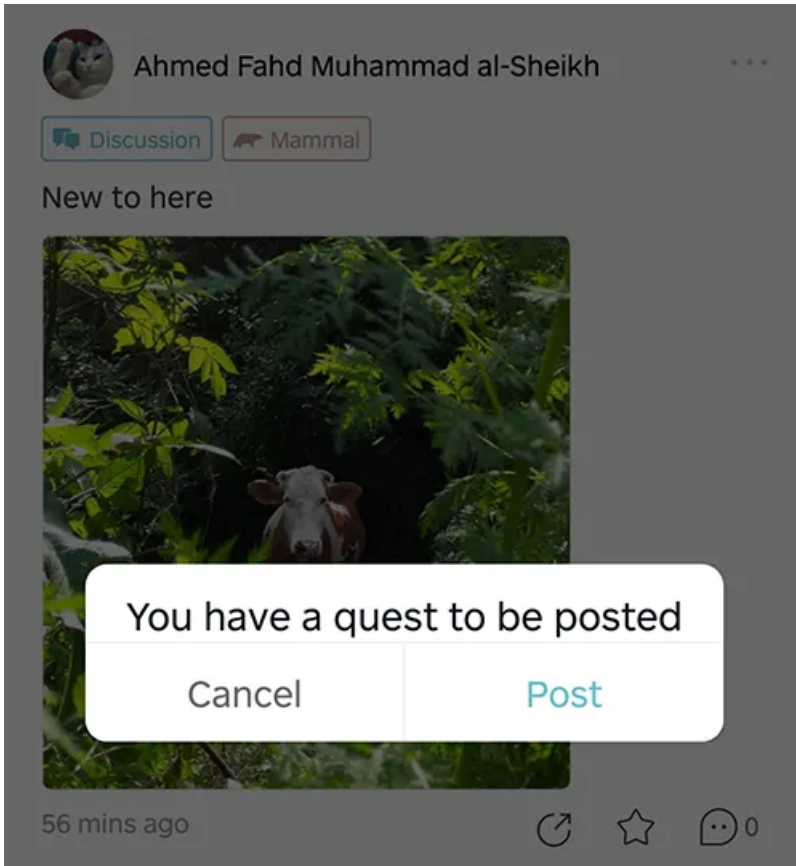

5. Type some content and tap **Post**.

The quest is published to IntelinkGO.

# Accepting A Quest

When you see a quest on IntelinkGO, you can choose to help the user synchronize data from the deployed device if the animal can be accessible to the [Intelink range](#) of your mobile.

Make sure that you have installed and logged in to IntelinkGO on your mobile.

1. Launch IntelinkGO, click into the quest and tap **Accept**.

The **Accept** button turns to **Quest detail**.

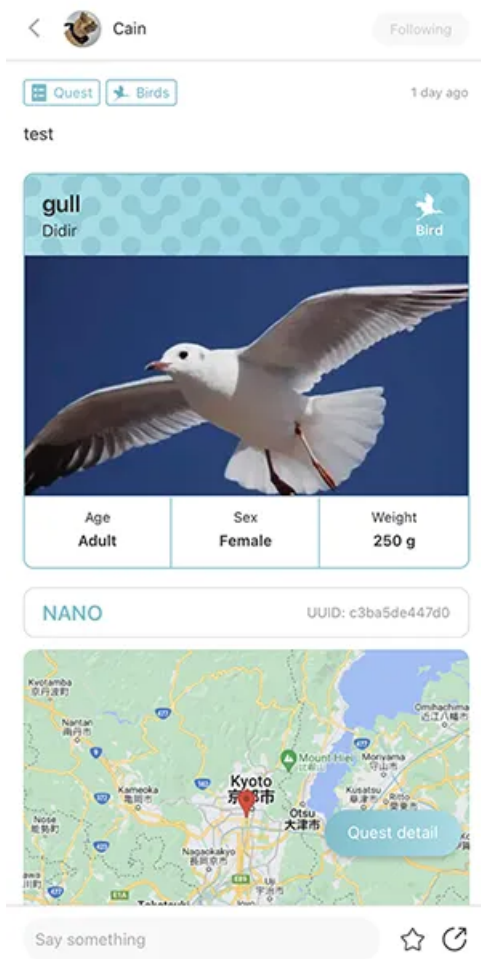

2. Go to the last location of the animal or anywhere you expect the animal to be according to the location info of the quest.

For map navigation, you can tap **Quest detail**, tap into the map and tap **Directions** to jump to map app on your phone.

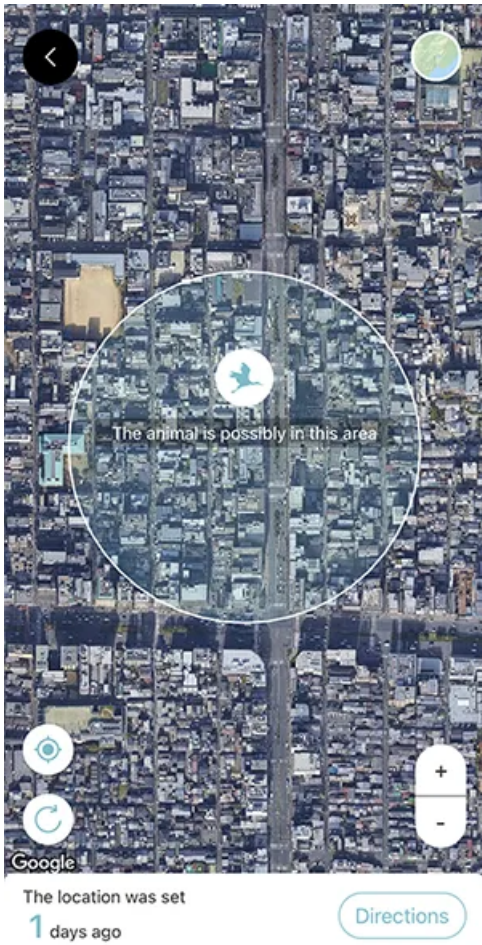

3. Tap **Quest detail** and tap **Find animal**.

IntelinkGO App begins to scan devices around. You can hold your phone and move around to look for the animal.

When you do this in the field, please watch out and take care of yourself.



4. When IntelinkGO App finds the animal, it will automatically synchronize data from the device.



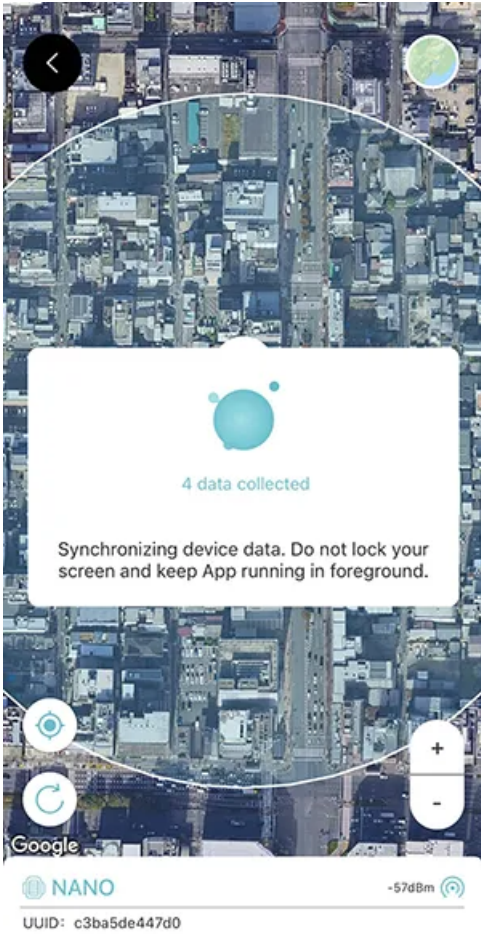

## Sharing Your Animal

Make sure that you have installed and logged in to IntelinkGO on your mobile.

1. Launch Ecotopia App and go to animal information page.

2. On the top right of the page, tap



icon.

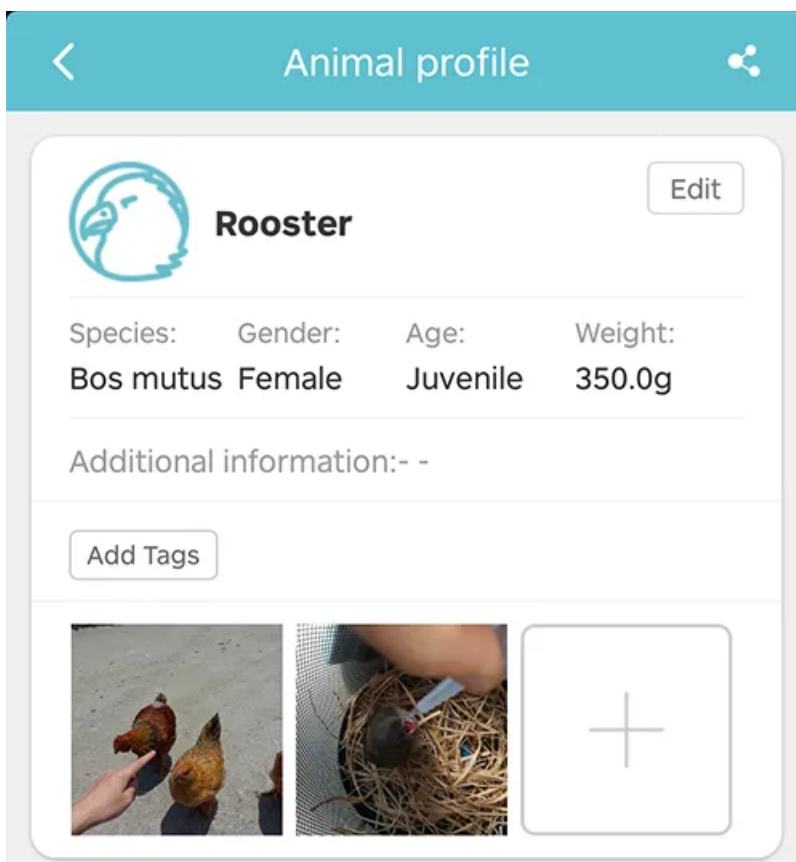

If you haven't created an animal, you will need to create one before proceeding any further.

3. Select data type that you need to share.

You can share the following content:

- Latest location: the latest location of the animal whenever other users check the post.
- 2D track: 2D track of history location data of any date range.
- 3D track: 3D track of history location data of any single day.

4. Set the expiration date.

5. Tap **Share to IntelinkGO**.

IntelinkGO is launched automatically. If you haven't installed IntelinkGO, you will be redirected to Google Play or App Store to install the App.

6. In IntelinkGO, you will see a pop-up message. In the pop-up window, tap **Post**.

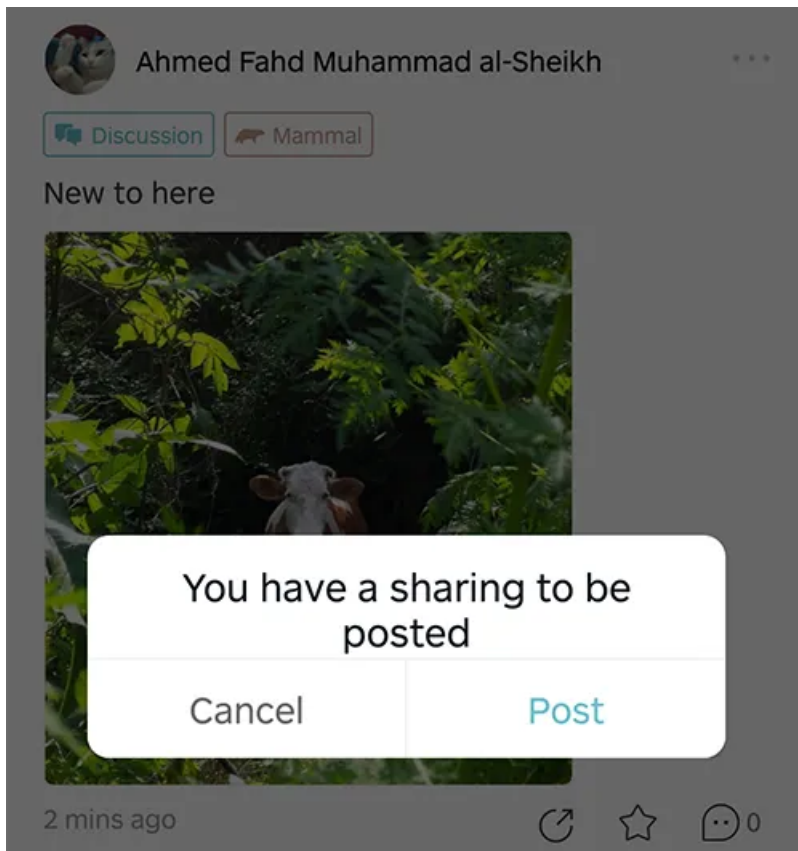

7. Type some content and tap **Post**.

The shared animal is posted to IntelinkGO.

# Changing Data Subscription Status

Step 1:

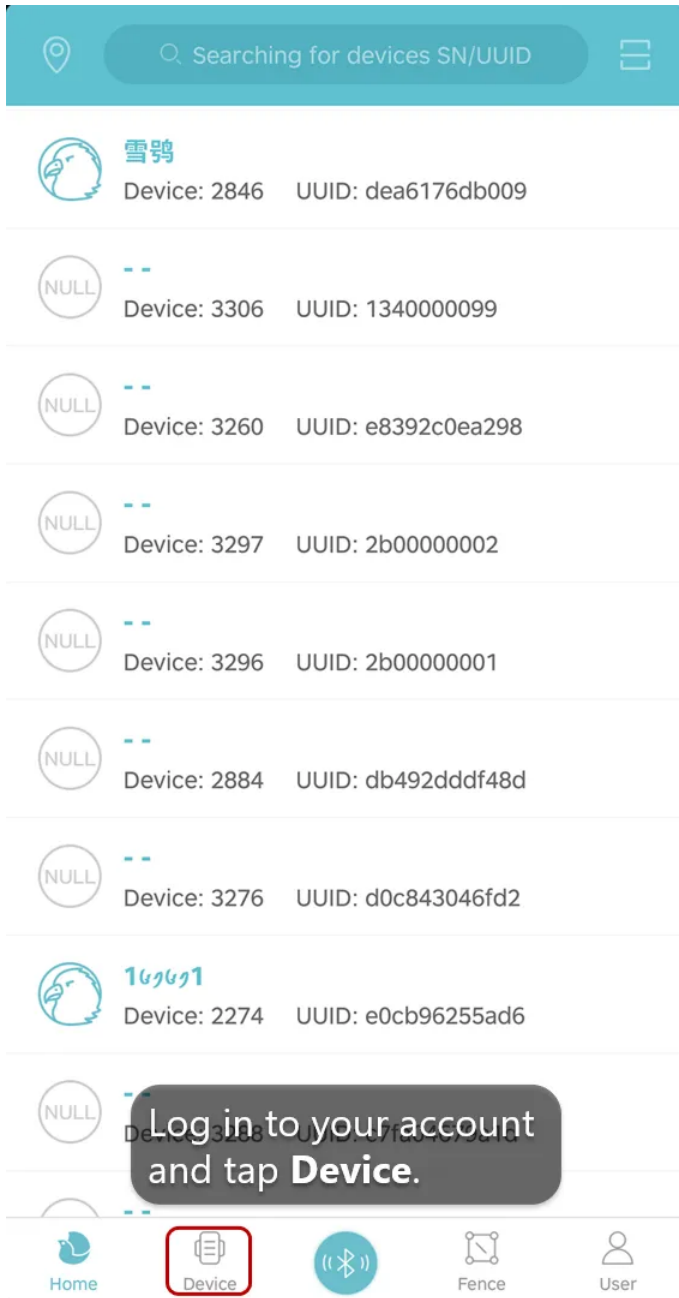

Step 2:



**144**  
Terminals



**20**  
Gateways

---

**3116** 30.5498496°,104.0594624°  
🔋 4.003V 🌡️ 38.8°C  
 Last GPRS session.2021-08-20 08:10:04

---

**2846** --  
🔋 4.152V 🌡️ 25.4°C  
 Last GPRS session.2021-08-18 06:55:35

---

**3306** --  
🔋 3.961V 🌡️ 0°C  
 Last GPRS session.2021-08-17 05:51:29

---

**3260** --  
🔋 3.985V 🌡️ 26.2°C  
 Last GPRS session.2021-08-09 08:11:22

---

**3297** --  
🔋 3.074V 🌡️ 0°C  
 Last GPRS session.2021-07-24 06:39:48

---

**3296** --  
🔋 -- 🌡️ 0°C  
 Last GPRS session.2021-07-24 02:26:04

---

**2884** --  
🔋 4.007V 🌡️ 0°C  
 Last GPRS session.2021-07-21 23:59:53

---

**3276** --  
🔋 4.025V 🌡️ 0°C  
 Last GPRS session.2021-07-15 00:59:46

---

**2274** 38.747936°,-9.1667432°  
🔋 4.017V 🌡️ 37.7°C

Tap any device.

  
Home

  
Device

  
Bluetooth

  
Fence

  
User

Step 3:

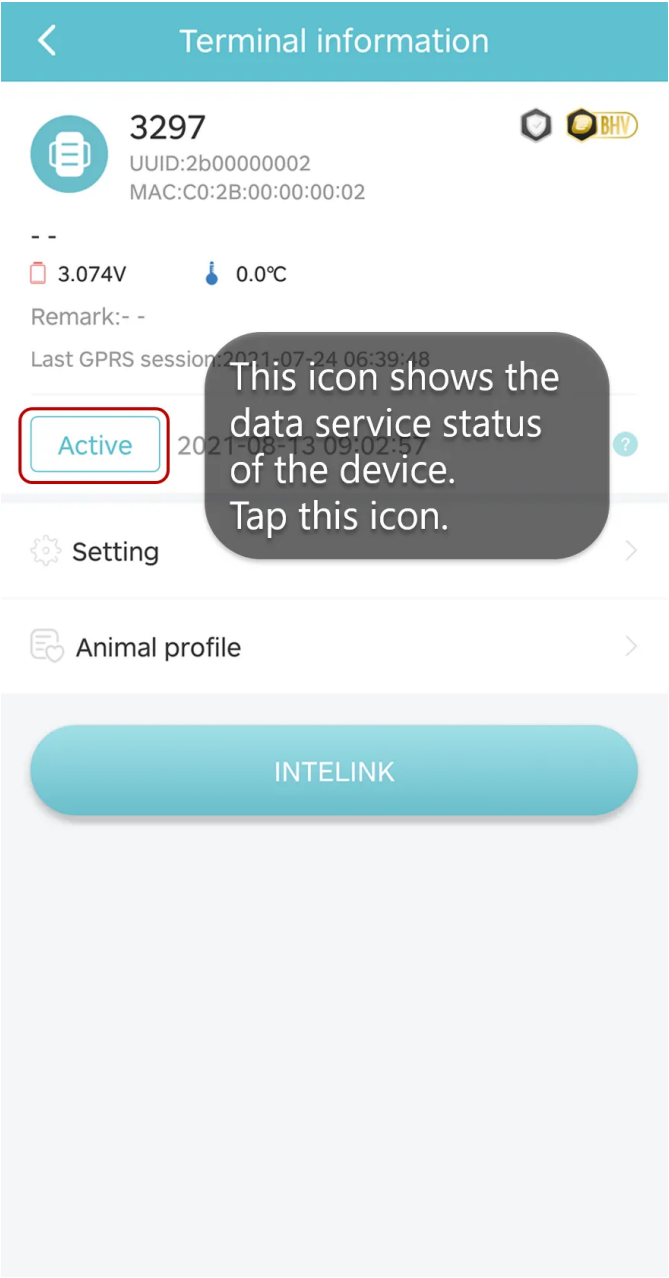

Step 4:

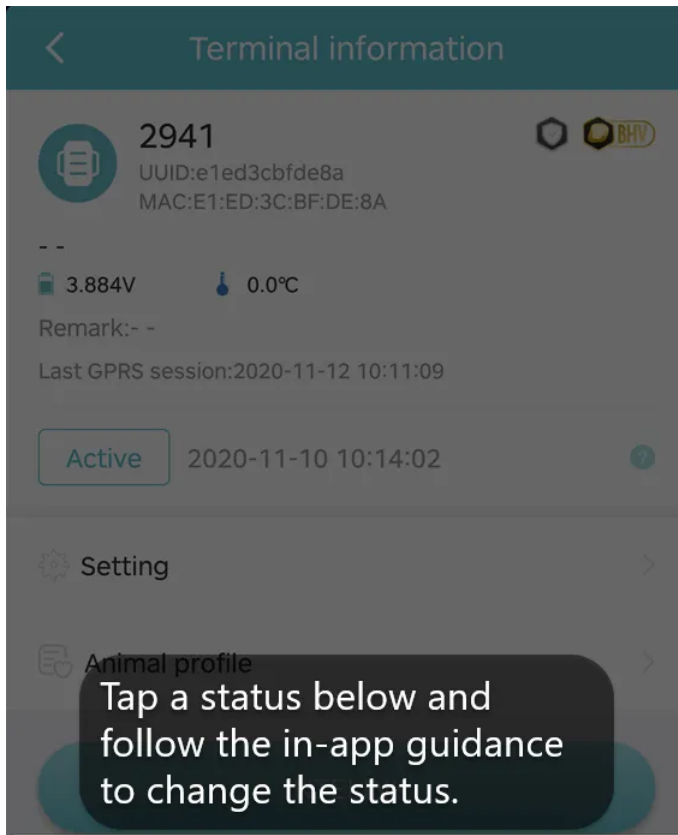

**Note:** After you change the status, you must wait for at least 2 months before you can change it again. Different status will be charged differently. For more information, see [here](#).

## Adding Terminals To The Whitelist Of A Gateway

This section gives the procedure to add a terminal device to the whitelist of a gateway device. Before using INTELINK to connect to other terminal devices through a gateway device, you must add the terminal to the whitelist of the gateway device.

1. In Ecotopia App, tap **Device**.  
App displays device list page.
2. On the device list page, tap **Gateway**.  
App displays gateway list page.
3. In the gateway list, tap any gateway.  
App displays gateway information page.
4. On the gateway information page, tap **Terminal list**.  
App displays the whitelist of the gateway.
5. On the upper right corner of the page, tap  icon.  
App displays the available terminal list page.
6. Tap the + icon to add this terminal to the whitelist of the gateway.



# Odba Subscription

Step 1:

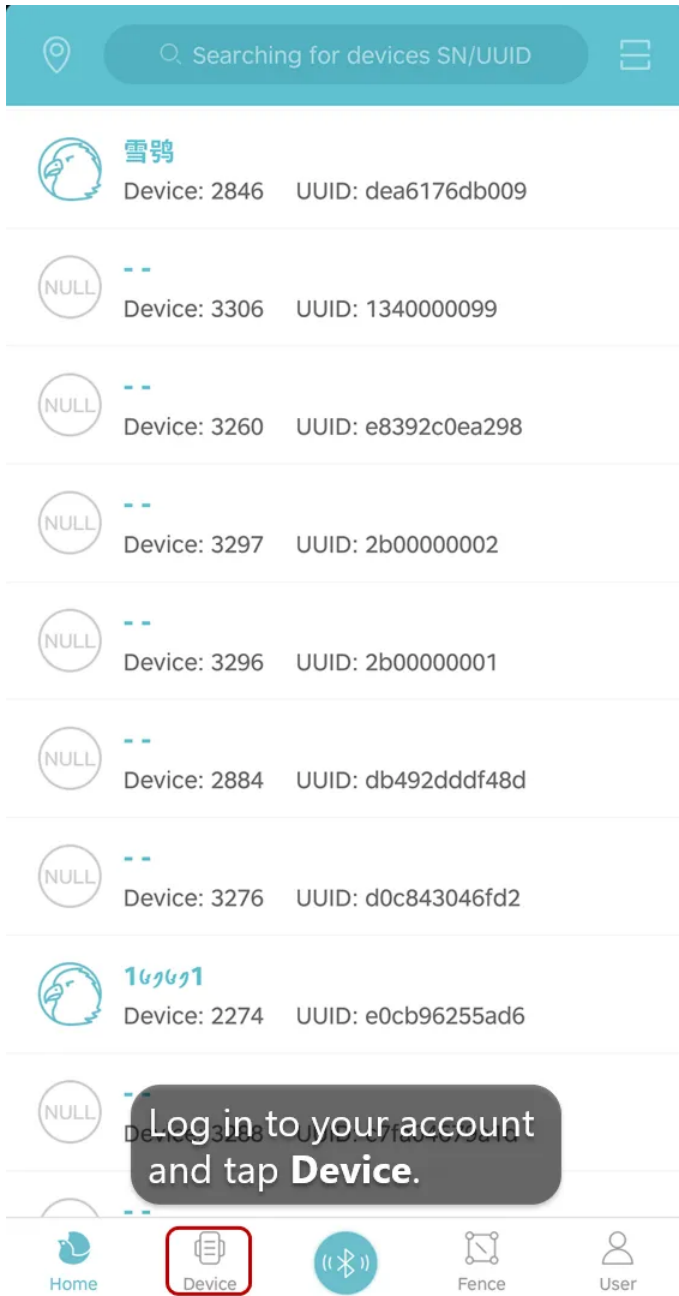

Log in to your account and tap **Device**.

Step 2:



**144**  
Terminals



**20**  
Gateways

---

**3116** 30.5498496°,104.0594624°  
🔋 4.003V 🌡️ 38.8°C  
 Last GPRS session.2021-08-20 08:10:04

**2846** --  
🔋 4.152V 🌡️ 25.4°C  
 Last GPRS session.2021-08-18 06:55:35

**3306** --  
🔋 3.961V 🌡️ 0°C  
 Last GPRS session.2021-08-17 05:51:29

**3260** --  
🔋 3.985V 🌡️ 26.2°C  
 Last GPRS session.2021-08-09 08:11:22

**3297** --  
🔋 3.074V 🌡️ 0°C  
 Last GPRS session.2021-07-24 06:39:48

**3296** --  
🔋 -- 🌡️ 0°C  
 Last GPRS session.2021-07-24 02:26:04

**2884** --  
🔋 4.007V 🌡️ 0°C  
 Last GPRS session.2021-07-21 23:59:53

**3276** --  
🔋 4.025V 🌡️ 0°C  
 Last GPRS session.2021-07-15 00:59:46

**2274** 38.747936°,-9.1667432°  
🔋 4.017V 🌡️ 37.7°C

Tap any device.

  
Home

  
Device

  
Bluetooth

  
Fence

  
User

Step 3:

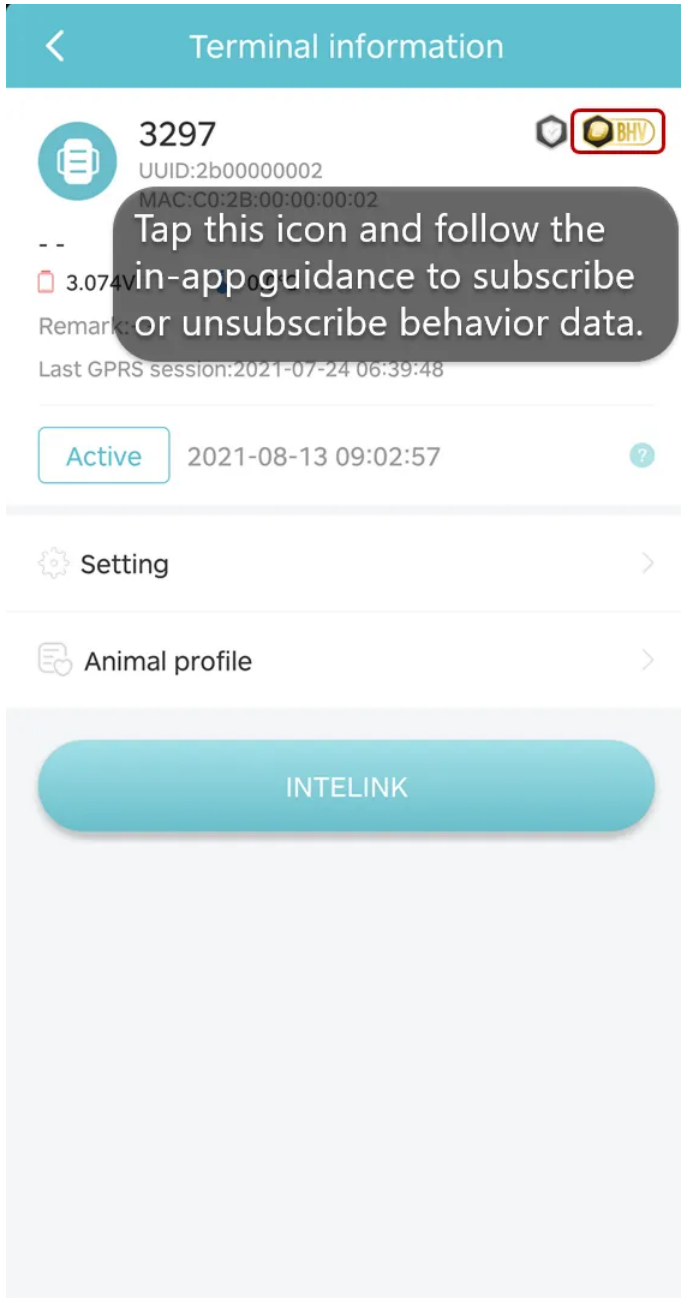

**Note:** ODBA subscription is only applicable for **active** device. After you subscribe or unsubscribe ODBA, you must wait for at least 2 months before you can unsubscribe or subscribe it again.

## Changing Device Setting

1. In Ecotopia App, tap **Device**.  
App displays device list page.
2. In the device list, tap the device you need to change the setting.  
App displays device information page.
3. On the device information page, tap **Setting**.  
App displays device setting page.
4. Change the settings as needed.  
You can change the following settings:
  - Environment&GNSS Sync  
When enabled, the collection mode and collection interval of environmental data will be consistent with the GNSS data collection, and cannot be changed separately.
  - GNSS data collecting  
Available options are **Interval**, **Follow transmission** and **Off**.
  - Interval  
Set the collecting interval when GNSS data collecting is set to **Interval**.
  - Environment data collecting  
Available options are **Interval**, **Follow transmission** and **Off**. This field is not available when **Environment & GNSS Sync** is enabled.
  - Interval  
Set the collecting interval when Environment data collecting is set to **Interval**. This field is not available when **Environment & GNSS Sync** is enabled.
  - ODBA collecting  
Available options are **Interval** and **Off**.
  - Interval  
Set the collecting interval when ODBA collecting is set to **Interval**.
  - Cellular  
Available options are **Interval**, **On-time** and **Combined**.  
This setting doesn't apply to INTELINK device, Argos device and Iridium device.
5. Click **Save** after finish.

For devices with a cellular module, the changed settings will take effect the next time the device communicates with the server. For devices that do not have a cellular module, the changed settings will take effect after the [setting is delivered](#) or the HUB associated with the device communicates with the server.

# Cache Management

Cache Management is useful when you are going to operate your device in an environment where your Ecotopia App cannot access the Internet.

Launch Ecotopia App and tap **User > Settings > Cache management**.

App displays cache management page as shown below.

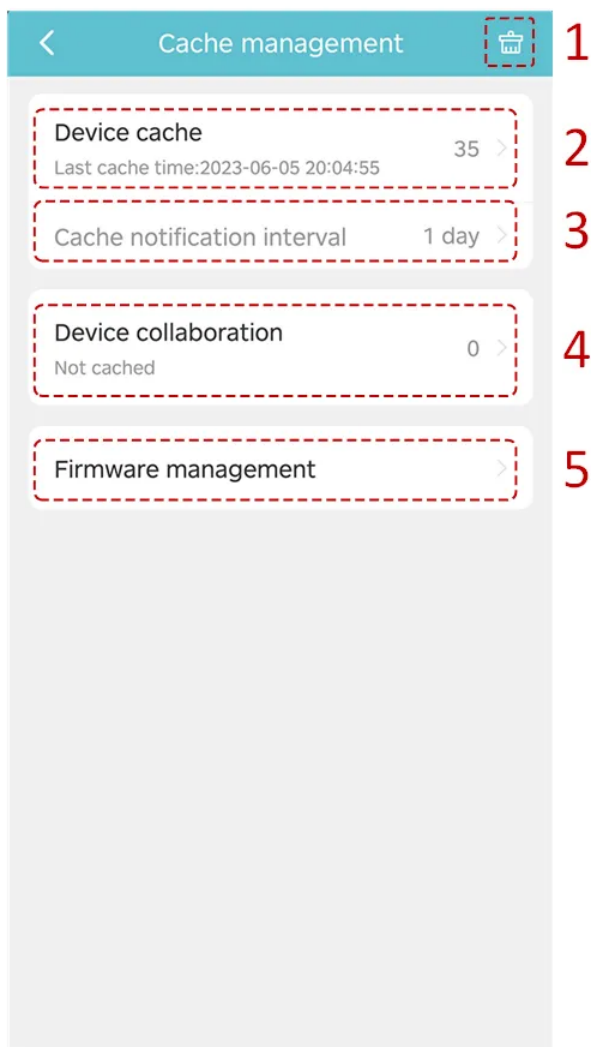

(1) Tap this icon to clear all the cached content from Ecotopia App.

(2) is the place to regularly get all device settings from the server, and store to your mobile. You can see all of your devices here.

(3) is for you to decide how often you want the App to remind you to cache the device information.

(4) is for you to decide whether you want to cache device collaboration related settings. If you want to operate a device from the collaboration group in a place without Internet connection, you must cache the related collaboration group in advance.

(5) is for you to cache the latest firmware on your mobile so that you can manually perform firmware upgrade without Internet connection. For more information, see [Firmware management](#)

## Firmware Management

You can use firmware management feature to download related firmware to your mobile phone so that you can upgrade the firmware of your devices when the network connection is not available.

Follow the instruction below to download firmware. Before you start, make sure that the network connection is stable.

1. Launch Ecotopia App and log in to your account.
2. Tap **User > Settings > Cache management > Firmware management**.  
App will get the firmware list from the cloud server as shown below.





## firmware management



**V202**

Published on 0001-01-01 Model --



59 KB



**V202**

Published on 0001-01-01 Model NANO



135 KB



**V220**

Published on 0001-01-01 Model NANO



136 KB



**V221**

Local

Published on 0001-01-01 Model NANO



136 KB



**V200**

Published on 2021-08-30 Model OMNI 2G



150 KB



**V225**

Published on 2021-08-30 Model OMNI 2G



150 KB



**V226**

Published on 2021-08-30 Model OMNI 2G



150 KB



**V225**

Published on 2021-09-01 Model OMNI 3G



149 KB



**V200**

Published on 2021-09-01 Model OMNI 3G



149 KB



**V100**



3. Tap the download icon at the right side of the firmware to download the relevant firmware.

Downloaded firmware is saved to your mobile phone. When you upgrade the firmware for you devices at the place without network connection, you can use the downloaded firmware to upgrade your devices.

## How can I retrieve account password?

If you are a sub account user, please contact your admin user to reset your password.

If you are an admin user, please contact Druid Technology via [support@druid.tech](mailto:support@druid.tech) to reset your password.

## Why is my Quest not under my account?

Please click [here](#) to get more information.

# Why are my newly received devices Suspended? How can I change it?

Please click [here](#) to get more information.

## Why is there an alarm icon indicating “Abnormal” for a device?

Please click [here](#) to get more information.

# How should a device be maintained if it will not be used anytime soon?

If you won't be using your devices for a period of time, e.g., over a battery charging cycle as shown below, please read the following instructions carefully and maintain them accordingly to ensure they are in optimal condition for test and deployment.

**Note:** Improper storage or no maintenance may result in permanent damage and void the warranty.

## Before device storage

1. Ensure the device is turned off.
2. Choose to change the data subscription status of the device to "Suspended". Note that after any status change, you must wait for two months before you can change the status again. Please consider this waiting period into your planning for future test and deployment, as you will need to change the data subscription status to "Active" for those activities.

## Device storage and maintenance

To maintain unused devices and help preserve the device warranty, follow these guidelines:

1. Proper storage environment
  - Store the device in an environment with a temperature ranging between -10°C and 35°C. It's recommended to place the device in an anti-static plastic bag and then store it in the crisper of a refrigerator. Avoid exposing the device to extreme temperatures below -20°C or above 60°C, as this may cause permanent damage.
  - Ensure the device is kept away from magnetic or electric fields, such as those generated by transformers.
  - Store the device in a secure location to prevent it from falling onto hard surfaces, which could result in damage.
2. Regular battery charging

- Charge the battery periodically as per the specified cycles based on the model.

This is especially **important** for models with **smaller batteries** like ULTRA. For some customized models, contact your sales representative for more info on battery charging cycle.

Model	Battery charging cycle
ULTRA / NANO P1 lite, etc.	1 day / 2 weeks
NANO / MINI / INTERREX / FLEX II, etc.	1 day / 4 weeks
FLEX II Argos / FLEX II MAX / LEGO, etc.	1 day / 8~12 weeks

- Confirm battery charging status and record the battery process

After each charging session, click the Intelink icon at the middle bottom of Ecotopia App to go to Intelink page and wait until the devices are detected (device UUIDs on the list change from grey to highlighted color).

Now check the battery level. If it is over 4 V, you can put away the devices. During this process, there is no need to turn on the devices or change the data subscription status.

**Note:** This step is crucial as it records your device maintenance activities. The records are uploaded when your phone has access to the internet, which is a **prerequisite for warranty**.

3. Do not attempt to disassemble the device yourself.

## How to charge X-Filming/Coating devices?

### Before you start

Make sure that you have the following things ready.

- Charger plug with Type-C wire

You need to prepare this by yourself. Make sure that it is with a maximum voltage of 5 V and a minimum ampere of 200 mA.



- Type-C Charger

This is supplied by Druid, with over-charging protection for the devices.



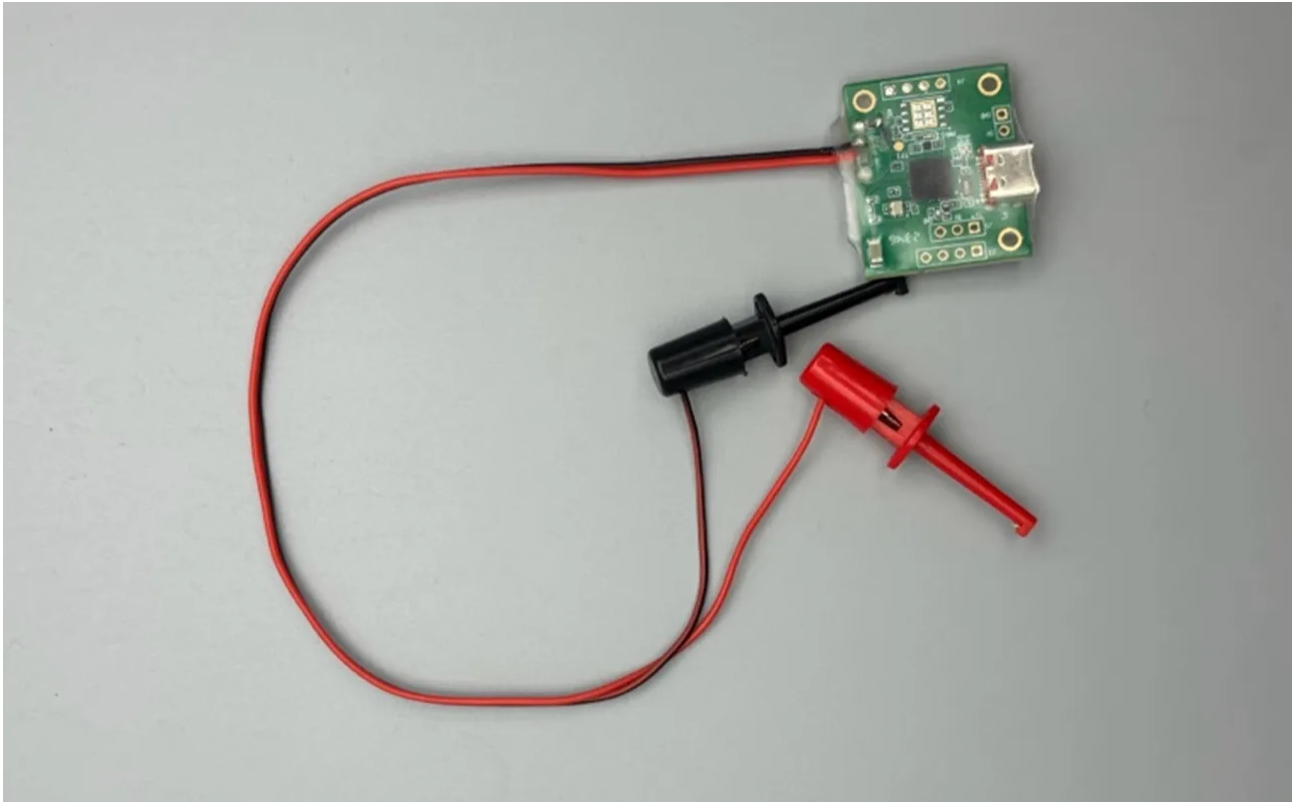

## Steps

1. Connect your charger plug to the Type-C charger.

2. Prepare the device.

Identify the 2 black and 2 red wires on the device for battery charging, and remove the tip insulation from one black and one red wire. (Two wires for each color is for the purpose of backup, in case the wire damaged in the wild environment.)

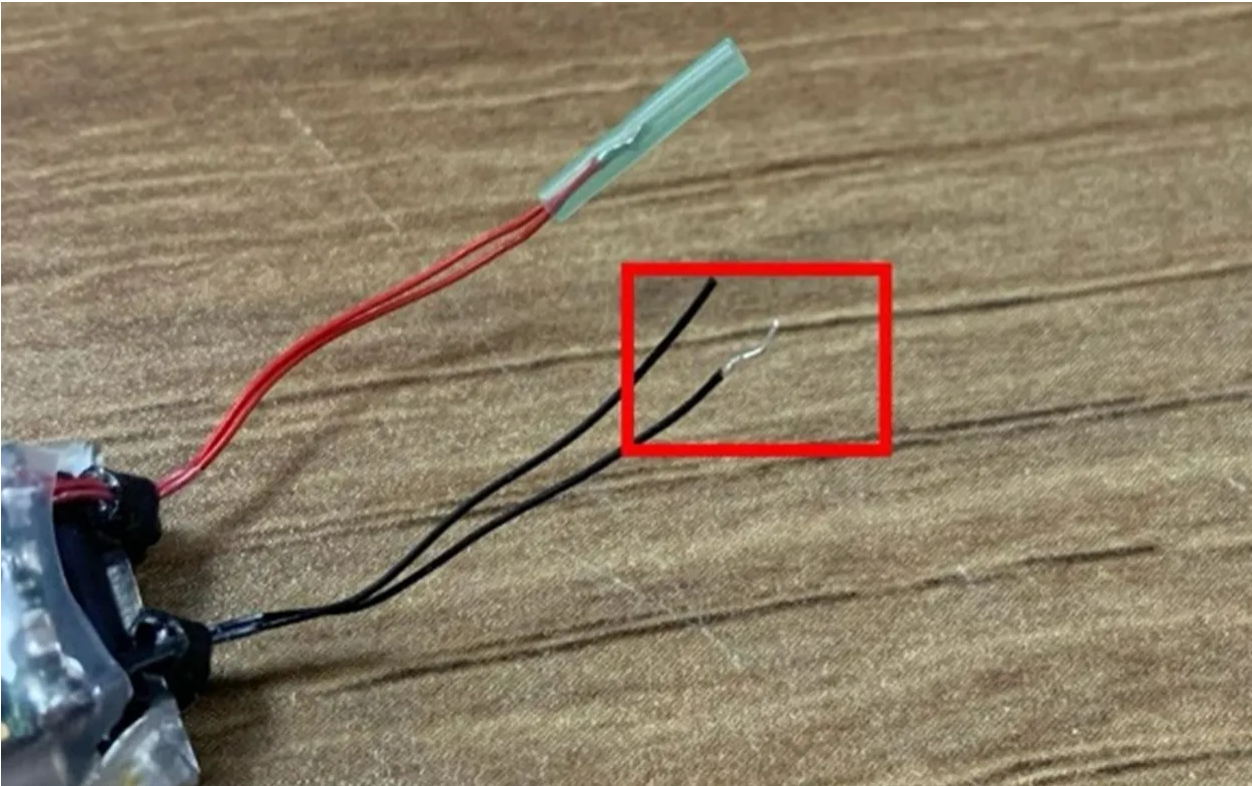

3. Connect the charger to device.

Connect the hooker parts of the charger to the exposed wires of the matching color.

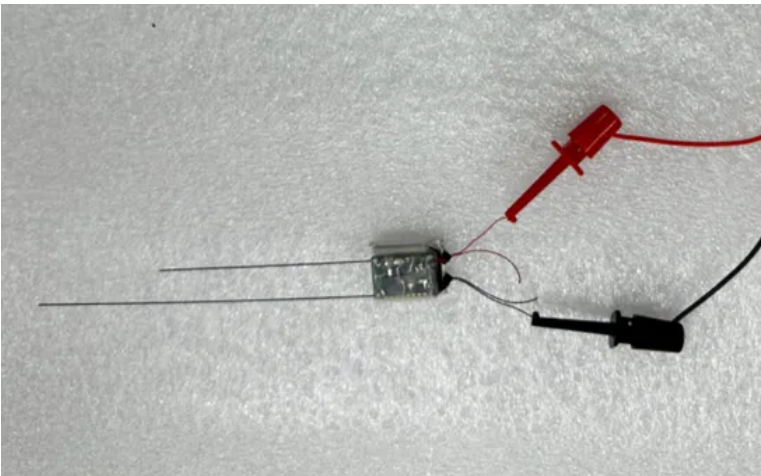

4. Initiate charging.

Connect the charger plug to the power supply, and the blue/green LED on the charger will start blinking, indicating that the battery is charging. Once fully charged, the blue LED will remain constantly on.

The charging process typically takes 1 to 1.5 hours.

5. Confirm the charging progress.

Use INTELINK feature of Ecotopia App to search for devices. Devices highlighted in the INTELINK scanning result page will show its current battery voltage, as below.

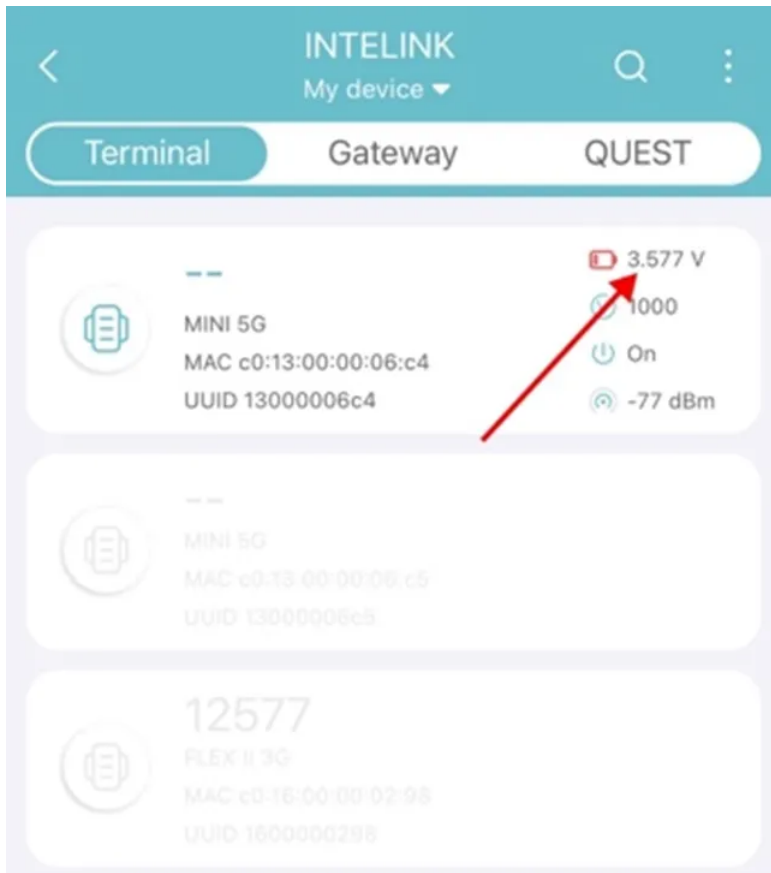

Voltage at around 4.15 V indicates that the battery is fully charged. Then, disconnect the charger plug and remove the device from the charger.

6. Insulate the charging cables on the device.

Wrap the exposed core part with anti-static high-temperature tape to complete the insulation process.

### Important Notes

Charge devices while powered off for faster charging and to prevent unintentional power consumption post-charging. In energy-saving scenarios, disable BOOST or Edge Intelligence features of the cable-charging models to optimize power management.

For any additional assistance, please contact [support@druid.tech](mailto:support@druid.tech).

## How can I determine if the battery is charging OK?

Firstly, ensure that the device is operating at standard working frequency to prevent excessive power consumption during charging.

Secondly, make sure the device is placed in an open space with no shading during the charging process and avoid charging through glass.

Next, monitor the charging time of the device, which can be compared to the standard charging duration provided [HERE](#). If the device takes significantly longer to charge compared to the standard duration, it may have a charging issue.

For models that are not listed, you can perform a charging comparison by observing multiple devices of the same model with the same configuration charging in a similar environment. Create a voltage trend graph with the Analysis feature on Ecotopia and watch for any significant voltage anomalies in one of the devices. If one device exhibits a noticeable abnormal voltage trend, it may have a charging issue.

**Note:** When comparing the charging of multiple devices, if the initial voltage values are not consistent, it may result in inconsistent voltage trend patterns. It is recommended to start observing when the devices have relatively consistent initial voltages.

# What are the working voltage thresholds for DEBUT devices?

For different models with different transmission methods, battery capacity, etc., tests have been carried out and optimized working voltage thresholds have been set.

## Cellular Model - Working Voltage Thresholds (V)

	GNSS Data	ENV Data	ODBA Data	Transmission (Cellular)
FLEX II 3G MAX/LEGO 3G	3.67	3.65	3.65	3.72
FLEX II 3G	3.70	3.67	3.67	3.75
FLEX 2G/LEGO 2G	3.67	3.65	3.65	3.72
MINI 5G/INTERREX 5G	3.67	3.65	3.65	3.72
MINI 4G/INTERREX 4G	3.7	3.67	3.67	3.75
MINI 2G/OMNI 2G/INTERREX 2G	3.75	3.72	3.72	3.80
ULTRA 5G	3.72	3.70	3.70	3.77

**Note:** For earlier version of FLEX 2G and LEGO 2G, the GNSS data collection voltage threshold is set at 3.65 V.

## INTELINK Model - Working Voltage Thresholds (V)

	GNSS Data	ENV Data	ODBA Data
NANO	3.7	3.67	3.67
ULTRA INTELINK	3.7	3.67	3.67
YAWL C2	3.7	3.67	3.67

**Note:** INTELINK transmission voltage threshold is not set. As the voltage drops, the INTELINK broadcasting of a device becomes less frequent (but doesn't stop), meaning it takes longer time to detect the device via a gateway like Ecotopia App or HUB.

## LoRa Model - Working Voltage Thresholds (V)

	<b>GNSS Data</b>	<b>ENV Data</b>	<b>ODBA Data</b>	<b>Transmission (LoRa)</b>
<b>MINI LoRa</b>	3.67	3.67	3.67	3.77

### Satellite Model - Working Voltage Thresholds (V)

	<b>GNSS Data</b>	<b>ENV Data</b>	<b>ODBA Data</b>	<b>Transmission (Satellite)</b>
<b>MINI Argos</b>	3.7	3.67	3.67	3.7

## How to wake up a "sleeping" battery (of micro battery models like ULTRA series)?

To achieve extreme light weight, ULTRA series and some customized NANO models (like NANO M1 lite) use micro rechargeable lithium battery. Sometimes, after long-time shipment with zero light, a micro battery naturally drains (an inherent quality of lithium battery) and may enter "sleeping" mode, which requires stronger light to wake it up for further battery charging.

You have 2 options to wake up the battery:

- Direct sunlight wake-up (for very strong sunlight)  
Place the device under direct sunlight of around 80000 lx for over 30 minutes. Then the battery will wake up and keep on charging until it is fully charged.
- Using a convex lens (for weaker sunlight)
  1. Keep the convex lens (diameter: 7cm) vertical to sunlight. And sunlight is focused at the focal point.
  2. Place the solar panel at the focal point, vertical to the focused sunlight, for about 10s. The battery will wake up.
  3. Keep on charging the battery under regular sunlight until it is fully charged.

Improper maintenance may also lead to "sleeping" battery. Please [maintain the device properly](#).

Note that "sleeping" battery won't happen after deployment as there won't be long time of zero light after deployment.

# How long does it take to charge the device battery?

For models with different solar panels and batteries, charging time can vary. Below models (continue to be updated) are provided for your reference.

Model	Sub model	Solar panel	Battery	Light intensity by device*	Actual light intensity*	r_Pearson*	Charging time
MINI	MINI 2G	15 mm * 15 mm GaAs solar panel	30 mAh	45704 lux	70000 lux	0.879	1.5~2.5 h
				15203 lux	50000 lux		2.2~3.7 h
				8150 lux	40000 lux		3.0~5.1 h
				5865 lux	30000 lux		3.7~6.2 h
				1822 lux	7000 lux		17~28 h
NANO	NANO	8 mm * 16 mm GaAs solar panel	40 mAh	73685 lux	70000 lux	0.995	3.4~5.6 h
				57131 lux	60000 lux		4.1~6.8 h
				52307 lux	50000 lux		5.1~8.5 h
				40589 lux	40000 lux		7.2~12 h
				21926 lux	20000 lux		16~26 h
				11319 lux	10000 lux		33~54 h
	NANO P1	5 mm * 20 mm GaAs solar panel	40 mAh	70818 lux	70000 lux	0.996	5.0~8.3 h
				60629 lux	60000 lux		6.1~10 h
				54175 lux	50000 lux		7.6~13 h
				38375 lux	40000 lux		10~17 h
				22821 lux	20000 lux		18~30 h
				13457 lux	10000 lux		36~60 h
LEGO	LEGO	43.7 mm * 13.8 mm c-Si solar panel	210 mAh	1045 lux	70000 lux	0.841	13~22 h
				911 lux	60000 lux		16~26 h
				150 lux	50000 lux		17~28 h
				170 lux	40000 lux		22~37 h
				164 lux	25000 lux		42~71 h
				75 lux	15000 lux		69~115 h
	LEGO EL 40	41.6 mm * 21.6 mm c-Si solar panel	210 mAh	2077 lux	70000 lux	0.9	8~14 h
				1919 lux	60000 lux		10~17 h
				1925 lux	50000 lux		12~21 h
				1868 lux	40000 lux		14~24 h
				273 lux	25000 lux		26~43 h
				170 lux	15000 lux		44~73 h



\*Light intensity by device: Light intensity as collected by light sensor of the device itself. It is different from actual light intensity of the environment, as being influenced by housing materials and shapes.

\*Actual light intensity: Actual light intensity of the environment. According to Wikipedia, 10,000 lx to 25,000 lx is defined as full daylight (not direct sun) while 32,000 lx to 100,000 lx is defined as direct sunlight.

\*r\_Pearson: Linear correlation between Light intensity by device and Actual light intensity

**Note:**

- Above data is based on natural daylight instead of artificial light source, and the light is vertical to the solar panel surface.
- For some models with micro battery, after long-time shipment, the battery naturally drains and may enter sleeping mode, which requires stronger light to [wake it up](#) for further battery charging.
- For models that charges with a cable, a HUB can be fully charged for around 8 hours and a QUEST can be fully charged for around 2 hours.

# How to charge the device manually when the weather condition is not good?

To manually charge the device, it is suggested to use xenon lamp or halogen lamp as the light source. Among the two, xenon lamp has stronger light and thus leads to faster charging. The bulb power should be selected between 150-300 W, as higher power results in faster charging speed. Yellow light is slightly better than white light.

A xenon lamp also goes with a BALLAST, and both xenon and halogen lamp need a spotlight cover and a power supply. Prepare necessary items before usage. Due to the high temperature of these lamps, it is recommended to use a tripod for stability during use, facilitating temperature adjustment and safe operation. We suggest searching for keywords like "xenon headlamp" or "xenon camping lamp" on shopping websites, as the lamps that appear in the search results usually come with spotlight.

Charging process:

1. Connect the power supply and turn on the lamp.
2. Place the device under the spotlight, with the device's solar panel perpendicular to the light source.
3. The distance between the device and the light source is influenced by the power of the light bulb; the greater the power, the greater the distance. We recommend that you monitor the environment data of the device and adjust the distance during the charging process to ensure that the temperature in the environment data does not exceed 60°C.

According to the results of our laboratory tests, it takes approximately 20 hours to charge a 40 mAh battery from 3.6 V to 4 V at a distance of 15 cm. The light source we used is a 100 W xenon lamp.

**Note:** Protect your eyes from strong light damage during the process. Keep the lamp away from flammable materials for safe charging.



# How long is the battery life of DEBUT devices? How many GNSS fixes can it collect?

The battery life of a device refers to the duration a fully charged device can operate before it pauses due to the battery level dropping below the operational threshold. This duration is influenced by several factors:

## 1. Battery capacity

The battery capacity varies in different devices. For example, the battery capacity of MINI is 30 mAh, the battery capacity of LEGO is 210 mAh, and the battery capacity of BADGE is 19000 mAh. The battery capacity of other customized products is also different. Different battery capacity will have an important impact on the battery life.

## 2. Efficiency of solar charging

In clear summer daytime, it usually takes 1 to 2 days to fully charge the battery for most of the devices if the solar panel of the device is exposed to direct sunlight. While in winter or cloudy days, or the device is in an environment where it cannot be exposed to direct sunlight, it may not be able to charge the battery effectively. At this time, you need to lower the frequency of transmission and data collection to maintain the power balance, and wait for the light condition to improve.

## 3. Power consumption difference

Different device functions require varying levels of power consumption. For instance, tasks like environmental data and ODBA collection typically demand minimal power, whereas GNSS positioning and data transmission rank among the most energy-intensive functions.

Moreover, the power consumption of a specific function can be influenced by several factors. Take GNSS positioning as an example: its power usage is affected by the GNSS time consumption. Generally, the longer the positioning process takes, the greater the power consumption. This positioning time varies depending on different settings and environmental conditions. Typically, it falls within the range of 30 to 60 seconds after deployment. However, under BOOST mode activation, GNSS positioning can be completed in as little as 2 to 5 seconds. Conversely, in unfavorable GNSS environments, it may extend to 90 seconds or more.

During test, scenarios such as being indoors without a clear sky view can significantly prolong the positioning process. In such cases, it's not uncommon for the positioning time to reach up to 150 seconds without achieving successful results.

As a result, it is difficult to have an accurate estimation of battery life without an comprehensive understanding of the living environment and habits of the specific animal.

You can refer to the following case as a benchmark. The prerequisite is no charging and the device is in an open area without liquid and electromagnetic interference.

1. BADGE C4 4G, 9000 mAh, GNSS 1h/ENV 1h/ODBA 10min/Transmission 8h, GNSS consumption time 30 ~ 90 s, battery life 290 ~ 726 days, i.e., 6960 ~ 17424 GNSS fixes.
2. LEGO 4G, 210 mAh, GNSS 1h/ENV 1h/ODBA 10min/Transmission 1day, GNSS consumption time 30 ~ 90 s, battery life 5 ~ 13 days, i.e., 120 ~ 312 GNSS fixes.
3. MINI 4G, 30 mAh, GNSS 1h/ENV 1h/ODBA 10min/Transmission 1day, GNSS consumption time 30 ~ 90 s, battery life 1 ~ 2 days, i.e., 18 ~ 46 GNSS fixes.
4. ULTRA 5G, 15 mAh, GNSS 6h/ENV 1h/ODBA 10min/Transmission 1day, GNSS consumption time 30 ~ 90 s, battery life 2 days, i.e., 6 ~ 13 GNSS fixes.

## What's the lifespan of a device (battery)?

The lifespan of a device is determined by the lifespan of its battery. As long as the battery is OK, the device can work fine.

Generally, the lifespan of a lithium battery is 2~3 years. After that, the performance of a lithium battery will begin to degrade gradually. But it can still work. Some Druid's devices have been working for over 6 years now.

## Why the battery of a device is continuously at a low level?

Please click [here](#) to get more information.

## Does it mean the device is turned on when the status is set to Active?

On/off is the status of the device hardware. A device is [turned on](#) so it can work (collect data and transmit data to the server via cellular networks, gateway or satellite), and it stops working when it is turned off.

[Data subscription status](#) (Active, Inactive, Suspended and Terminated) is the status of data subscription items you can use, including data subscription, data platform function and cloud service.

For example, turning on a device doesn't mean you can use the data service items. You still need to [change data subscription status](#) on Ecotopia data center or Ecotopia App to use the relevant data service items.



## Can a device be turned on if App is not connected to internet?

Yes. However, on conditions that you have logged on to Ecotopia App and have [cached all necessary information](#) in your mobile phone beforehand.

## How to check if a device is turned on?

You can check if a device is turned on or not with the following methods:

- Scan the device with INTELINK

Shake the device till the LED blinks. Launch Ecotopia App at tap



icon at the bottom while the LED is blinking. App lists all your devices. You can see if a device is turned on in the list.

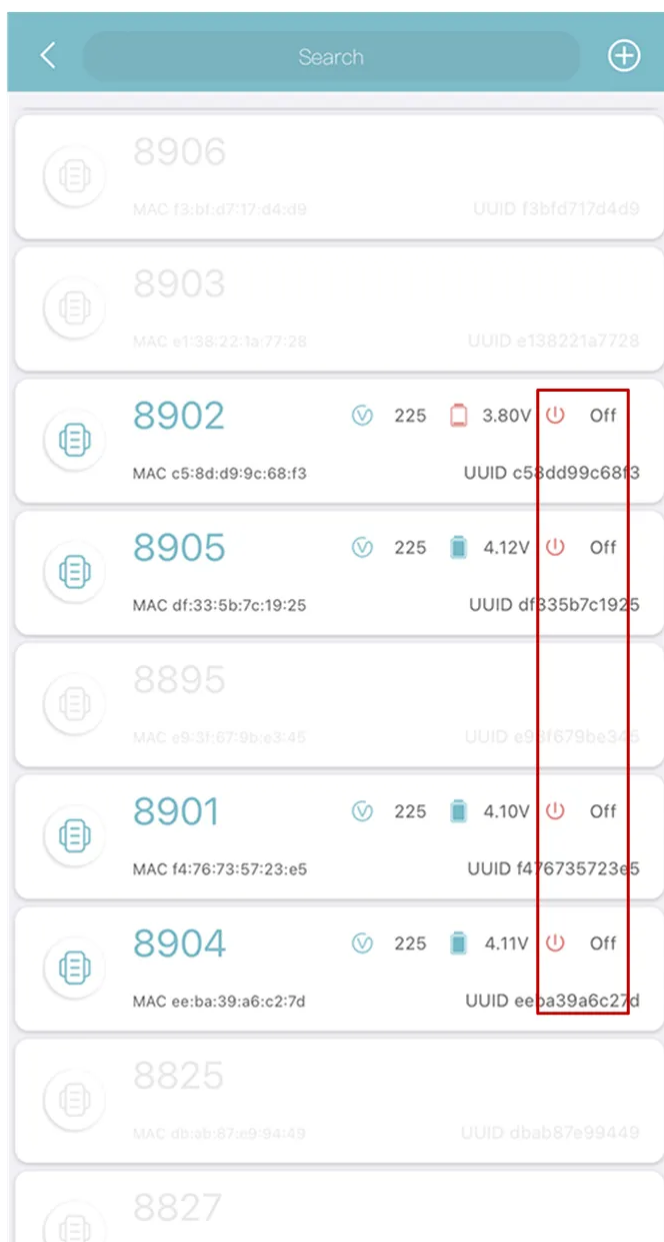

- Shake the device and observe the LED

If the device's LED light does not respond, the device is turned on; if the device's LED starts to

flash, the device is turned off.

## **Will my DEBUT device be turned off when the battery level is low?**

A DEBUT device will not be turned off due to low battery level. It will only temporarily "sleep" under the over-discharging protection scheme for the battery. When the battery level goes up, the device will "wake up" and resume working automatically.

## What should I do if I forgot to turn on a deployed device?

If the device is a cellular model that transmits via cellular network, please contact us to enable 7-day waking up for the device. A device is designed to synchronize its on/off status with our server every 7 days since the last turning off. The 7-day waking up feature is disabled by default, as to save power when the device is not used. When this feature is enabled, the device will receive the command to "wake up" (turn on) during its synchronizing session with our server. The success requires adequate network signals. If unsuccessful, it will wait for another 7 days for another try.

If a device is an INTELINK model, you can try to get within the [INTELINK range](#) and turn it on with a mobile phone or a [gateway device](#).

## Why are devices not found by Ecotopia App via INTELINK?

Please click [here](#) to get more information.

## Why too short working intervals should be avoided?

Too short working intervals, e.g., 1 hour for transmission or 5 minutes for GNSS, is designed for device test purpose. When drastic battery drop happens, you can re-charge the battery as the device is at your hand.

However, when a device is deployed to an animal, please refrain from too frequent working intervals, for 2 reasons:

- Drastic battery drain can happen, which will lead to missing important data and losing communication. And lighting condition is unpredictable in the wild, which means you don't know when the battery will go up. So, too frequent working interval is very risky.
- BOOST can help you realize frequent working interval intelligently and protect the device from battery drain. So, too frequent working interval is not necessary.

Generally, it is suggested to use Standard setting, or make the transmission interval longer (if you are not in urgent need of data transmission) so you have more battery for data.

## Why are the data intervals not consistent with my setting?

Please click [here](#) to get more information.



## How to properly manage the setting of a device?

The aim of proper setting of a device is to achieve energy balance and collect as much data as possible at the same time. There are 2 ways to approach this aim:

- BOOST (Intelligent Dynamic Setting)  
BOOST can automatically adjust working frequency based on battery level and movement speed to achieve maximum utilization of battery. Click [here](#) to know more.

The default setting of BOOST (start and stop voltage threshold, speed threshold, working interval, etc.) is based on large amount of data and experience in the past, which is also adjustable. Please contact us for more information.

Unless you think a device is not able to charge properly for a period, it is suggested that you keep BOOST on for the device.

- User Programmed Setting  
When BOOST is on, you can also [change the device setting](#) with pre-set mode or customized mode. Below are suggestions on different charging conditions.
  - A battery curve (can be generated on **Analysis** page on data center) that fluctuates at a high level means good charging condition. In this case you can set the working frequency higher in a proper manner.
  - A battery curve that fluctuates at a normal level means normal charging condition. In this case you can keep the current working frequency as it is.
  - A battery curve that keeps dropping, or rises and drops but drops on a whole, means bad charging condition. In this case you can set the working frequency lower in a proper manner.

If you choose on-time transmission, it is suggested to set the time between 1~4 p.m. as in the time zone where the bird is located. Transmission failure because of low battery may occur less as battery level is higher during this period than at other times.



## When does the changed setting take effect?

For cellular (2G/3G/5G) devices, the setting is saved to the cloud server after you modify it with data center or App. When the device communicates with the server next time, it will download and apply the new setting.

For near-field devices (such as NANO, YAWL or MINI LoRa), you must use [INTELINK](#) to [deliver the setting](#) to the device manually. If you have associated the device to DEBUT HUB with cellular function, HUB will fetch the new setting from the cloud server and deliver it to the device when connected.

After the new setting is applied, the device will begin to collect data as per the setting and the newly collected data will be transmitted during next transmission sessions. As a result, generally, only after 2 transmission sessions are you able to check data based on the new setting.

# What is BOOST

BOOST is short for **B**attery **O**ptimized **O**verclocking **S**trategy **T**uning, a condition-triggered feature that can increase the frequency of data collecting (GNSS and ENV) and transmission, of which the minimal collecting interval can reach 20 seconds, and can automatically return to your normal setting as programmed, relieving any worries of battery overconsumption. When BOOST is on, you don't have to adjust settings manually from time to time and can avoid possible improper settings that may cause battery drain or power waste. Besides, NO extra cost of data service fee is incurred during BOOST.

There are two modes of BOOST: the dynamic mode triggered by certain voltage thresholds, and the in-flight mode triggered by flight detection with medium to high voltage level.

- Dynamic mode

For dynamic mode, there can be multiple collecting frequencies triggered by multiple voltage thresholds. A higher voltage threshold triggers a higher collecting frequency. When the voltage is higher than a voltage threshold, the related collecting frequency is triggered. When the voltage falls below the voltage threshold, the related collecting frequency stops.

- In-flight mode

For in-flight mode, the collecting frequency is controlled by a voltage threshold, a high speed threshold and a low speed threshold.

In-flight BOOST is triggered when the following conditions are met at the same time:

- the voltage is higher than the threshold
- the speed is faster than the high speed threshold

In-flight BOOST stops when one of the following conditions is met:

- the voltage falls below the voltage threshold
- the speed is slower than the low speed threshold in the last 3 consecutive collectings

BOOST is designed to portray detailed movement track in a more "intelligent" way instead of manual intervention. Traditionally, the user has to monitor the device power status constantly so as to modify settings if they want more data without battery drain, while BOOST just

automatically regulates the intervals if the charging condition is good and the animal deployed with the device is active.

When BOOST is triggered, you can get much more GNSS fixes than usual. More GNSS fixes can bring more detailed reflection on the animal behaviour. With other collected data, you can get a more accurate profile for your study object. The illustration below shows the movement track of a bird in 30 minutes. This bird was deployed with DEBUT LEGO. When BOOST is on, LEGO collects more than 100 GNSS fixes in 30 minutes.

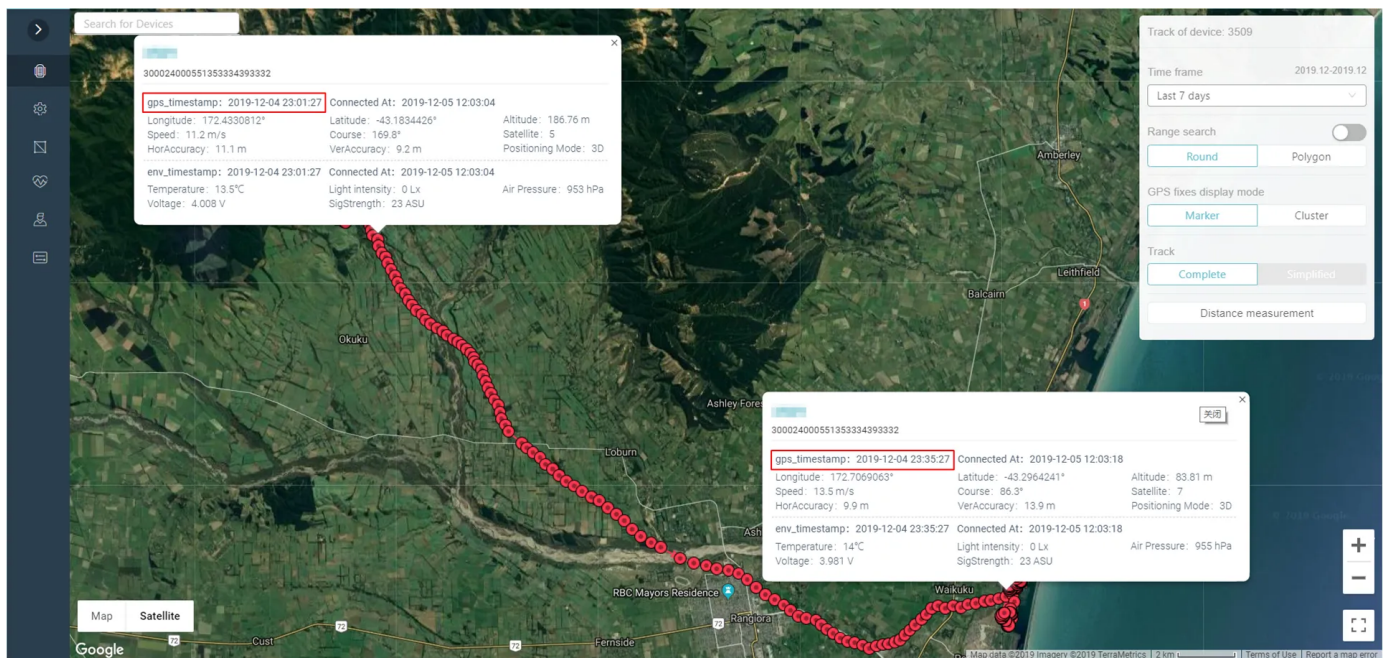

Please click [here](#) to watch an instruction video on how to set BOOST.

On this page >

# Edge Intelligence Instruction

Edge Intelligence empowers on-board decision-making for dynamic work scheduling, utilizing variables such as geofence, voltage levels, time range, speed, ODBA, temperature, and wet/dry, etc.

## Device Compatibility

Devices with firmware version 1006 and higher support Edge Intelligence feature. For devices running firmware versions below 1006, please reach out to [support@druid.tech](mailto:support@druid.tech) to explore the possibility of firmware upgrading.

To verify the firmware version of your device, utilize the INTELINK function within the Ecotopia App to establish a connection. The firmware version is displayed on INTELINK page, as illustrated below.

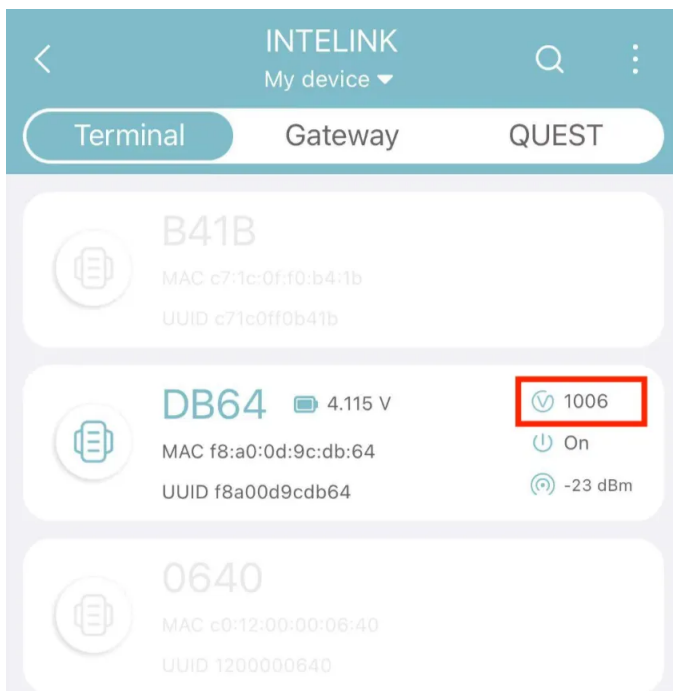

---

## Enable Edge Intelligence

Before proceeding, ensure that the Edge Intelligence feature is enabled. Click [here](#) to know how.

---

## Priorities

### Priority of Basic Setting and Edge Intelligence Setting

- When a setting item is enabled and has already been set in Basic Setting and it is included in an Edge Intelligence rule, if the Edge Intelligence rule is triggered, this setting item works according to the Edge Intelligence setting.
- When a setting item is enabled and has already been set in Basic Setting and it is not included in any Edge Intelligence rule, if any Edge Intelligence rule is triggered, this setting item is not influenced and works according to the Basic setting.
- When a setting item is disabled in Basic Setting and it is included in an Edge Intelligence rule, if the Edge Intelligence rule is triggered, this setting item works according to the Edge Intelligence setting.
- When a setting item is disabled in Basic Setting and it is not included in any Edge Intelligence rule, if any Edge Intelligence rule is triggered, this setting item remains disabled and doesn't work.

### Priority of Rules within Edge Intelligence Setting: Order of Rules

The order of Rules, from left to right, holds significant importance as it dictates their priority. You have the flexibility to adjust the sequence of Rules as necessary.

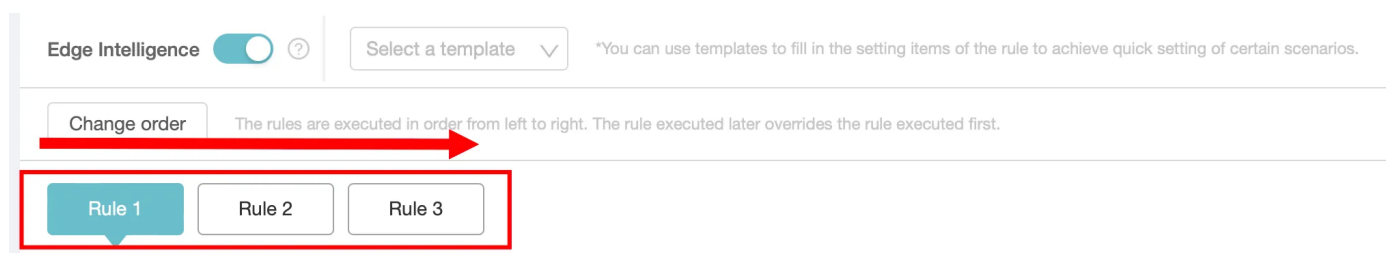

The screenshot shows the Edge Intelligence settings interface. At the top, there is a toggle for 'Edge Intelligence' which is turned on, and a 'Select a template' dropdown menu. Below this, there is a 'Change order' button and a text description: 'The rules are executed in order from left to right. The rule executed later overrides the rule executed first.' A red arrow points from the 'Change order' button to the three rules listed below: 'Rule 1', 'Rule 2', and 'Rule 3'. A red box highlights the three rules.

Here's a breakdown of how the system operates:

1. The device keeps checking the Conditions of all Rules systematically, one by one, proceeding from left to right, to determine if they are met. Rules with fulfilled Conditions are selected, while those whose conditions are not met are disregarded.
2. Subsequently, the device scrutinizes the Actions of the selected Rules, again from left to right, to check for conflicts. In case an Action item possesses conflicting settings across selected Rules, the settings of the Action item in the last Rule take precedence. If an Action item exists solely in one Rule, it is applied without contention.

## Variables

When assessing whether the Condition of a Rule is met, the device check the value of Variables associated with that Condition. It's important to note that Variable values are not updated in real time. Instead, their updating frequency is determined by both the user's data collection interval settings and the system's default settings.

Here's how the updating intervals are configured for specific Variables:

- **Voltage:** Voltage values can be updated through two methods: environment data collection and system default settings. Under 4.0V, the system defaults to a 5-minute update interval, while above 4.0V, it switches to a 1-minute interval. If environment data collection is disabled, only the system default settings apply.
- **Temperature:** Temperature values can also be updated through environment data collection and system default settings. The default update interval is set to 1 hour. If environment data collection is deactivated, only the system default setting is utilized.
- **Speed:** Speed values are updated exclusively through GNSS data collection. If GNSS data collection is turned off, this Variable becomes inactive.
- **Time Range:** Time range values are updated based on the system's default setting, with an interval of 8 seconds.
- **Geo-Fence:** Geo-fence values rely on GNSS data collection for updates. If GNSS data collection is disabled, this Variable becomes inactive.
- **Activity:** Activity values are updated through ODBA data collection. If ODBA data collection is disabled, this Variable becomes inactive.



## Templates

Please refer to the provided Edge Intelligence setting templates. Additionally, feel free to customize the Edge Intelligence settings according to your specific requirements.

- [Edge Intelligence Setting template for Geo-fence](#)
- [Edge Intelligence Setting Template for Time Schedule](#)
- [Edge Intelligence Setting Template for Flight Period](#)

## Edge Intelligence setting template for geo-fence

Before you start, you must [create a geo-fence](#) first.

Many airports pay special attention to the movement track and flight altitude of birds near the airport to plan and implement precise bird control project. This can also be applied to areas such as wind farms and high-voltage power lines.

- Basic Setting

- GNSS interval: 2 hour (adjustable according to device battery)
- ENV interval: 1 hour (adjustable according to device battery)
- ODBA interval: 10 min (adjustable according to device battery)
- Transmission interval: 8 hour (adjustable according to device battery)

Above settings are available on Ecotopia data center or App.

- Edge Intelligence Setting

Draw the key area where your research focus on (like airports, wind farms, or power lines) and the surrounding 50 km range as “Geo-fence A”. Draw another key area and the surrounding 5 km range as “Geo-fence B”. According to your previous few days tracking or paper research, the ODBA range during the target's flight is “X” to “Y”. The setting is shown as below.

Rules	Condition			Action	
Rule 1	And	Voltage>4	Activity>ODBAX	GNSS 10min	ENV 10min
Rule 2	And	Voltage>3.92	Enter Fence A	GNSS 5min	ENV 5min
Rule 3	And	Voltage>3.92	Enter Fence B	GNSS 1min	ENV 1min

- Setting Demonstration for Rule 1

The screenshot displays a rule configuration window for 'Rule1'. It is divided into two main sections: 'Condition' and 'Action'.

**Condition Section:**

- Condition relation:** 'and' (selected) or 'or'.
- Condition 1:** Variety: Voltage; Trigger: Higher than; Threshold: 4.00 V; Condition duration: Start now s.
- Condition 2:** Variety: Activity; Trigger: Higher than; Threshold: 5000; Condition duration: Start now s.
- An 'Add' button is located below the conditions.

**Action Section:**

- Action 1:**
  - Activate after: Once immediately s.
  - Setting item: GNSS collecting.
  - Mode: Interval.
  - Interval: 600 s.
  - Duration: Continuously s.
  - Expected transmission time (Timezone UTC+0): 2023-08-23 06:50:00.
- Action 2:**
  - Activate after: Once immediately s.
  - Setting item: Environment collect...
  - Mode: Interval.
  - Interval: 600 s.
  - Duration: Continuously s.

Above settings are only available on Ecotopia data center. After you finish, please delivery the setting with Ecotopia App or wait for the device to transmit once, then the settings will take effect.

- **Setting Description**

Before tracking targets entering the focus area, they often move fast. Therefore, by setting the ODBA value to capture initial movement, and the GNSS interval is increased for the first time, and then increased again when entering geo-fence A. Finally, a high-frequency collecting rate is achieved when entering geo-fence B.

In order to ensure the stability of the tracking device's battery and enable it to work for a long time, the voltage threshold is set relatively high. If the required data period is not long and the research purpose is only to obtain data in the focus area, the voltage threshold can be lowered. The frequency setting for GNSS can be modified but not removed. Other Action items can be added or deleted according to your research purpose.

**Note:** In the Edge Intelligence setting, the combined total of polygon geofence vertices and circular geofences for a device must not exceed 10. Otherwise, the Edge Intelligence setting will fail to be applied. For instance, Device A has 2 Edge Intelligence rules: 2 square geofences in the first rule and 1 circular geofence in the second. The total vertices of polygon geofences (8) plus circular geofences (1) equal 9, and the setting will be applied successfully.

However, Device B has 2 rules with 3 square geofences in the first rule and 1 circular geofence in the second. The total vertices of polygon geofences (12) plus circular geofences (1) equal 13, and the setting will not be applied.

Please test properly after delivery of Edge Intelligence setting to make sure it is applied.

# Edge Intelligence setting template for time schedule

Detailed movement information of species with large differences in day and night behavioral rhythms or seasonal behaviour can be achieved by making edge intelligence setting at a specific period of the day (such as night) or at a future period (such as days or months).

## 1. Different collection between day and night: Alpine chough (*Pyrrhocorax graculus*) as an example

Behavior characteristics: Alpine chough usually active during the day and living in caves at night.

Setting strategy: due to satellite signal limitation in the cave or forest, GNSS data collected at night is often invalid data, so GNSS collecting is turned off at night to save energy.

- Basic setting
  - GNSS interval: 2 h
  - ENV interval: 2 h
  - ODBA interval: 10 min
  - Transmission interval: 16 h
- Edge intelligence setting

Rules	Condition		Action	
Rule 1	and	Voltage > 3.7	GNSS 10min	
Rule 2	and	Voltage > 4.02	GNSS 2min	Transmission 5min
Rule 3	and	Enter the daily time range of 21:00~06:00	GNSS off	
Rule 4	and	Enter the daily time range of 21:00~06:00	ODBA > X	GNSS 10min

Note: X is the ODBA value based on observations or papers.

- Setting Demonstration for Rule 4

Rule name: Rule 4

Condition: and

Condition relation: and (selected), or

Variety: Time range

Trigger: In

Timezone: UTC+0

Time type: Every day

Every day: 21:00:00 → 06:00:00 \*1 9h 0m 0s

Action: Activate after (Once immediately)

Setting item: GNSS collecting

Mode: Off

## 2. The sleep mode collection: squirrels as an example

Behavioral characteristics: hibernation in winter, during which activity stops or occasionally occurs, and normal activity resumes in the coming spring.

Setting strategy: due to satellite signal limitation, GNSS data collected during hibernation is often invalid data, so GNSS collecting is turned off during hibernation to save energy.

Meanwhile, the GNSS sampling frequency and transmission interval were increased when the wake is detected by ODBA determining the wake up during hibernation.

- Basic setting
  - GNSS interval: 4 h
  - ENV interval: 4 h
  - ODBA interval: 10 min
  - Transmission interval: 16 h
- Edge intelligence setting

Rules	Condition			Action	
Rule 1	and	Enter from November to March	ODBA<120	GNSS off	
Rule 2	and	Enter from November to March	ODBA>500	GNSS 1h	Transmission 1h

- Setting Demonstration for Rule 2

Rule name: Rule 2 New Cancel

Condition [View help](#)

Condition relation

and  or

Variety <input type="text"/>	Trigger <input type="text"/>	Timezone <input type="text"/>	Time type <input type="text"/>	Unix time <input type="text"/>
Time range	In	UTC+0	Unix time	2023-11-01 00:00:00 → 2024-03-01 00:00:00 121D 0h 0m 0s

Action [View help](#)

Activate after <input type="text"/>				
Once immediately s				
Setting item <input type="text"/>	Mode <input type="text"/>	Interval <input type="text"/>	Duration <input type="text"/>	Expected transmission time (Timezone UTC+0)
GNSS collecting	Interval	3600 s	Continuously s	2023-08-23 08:00:00

Activate after <input type="text"/>			
Once immediately s			
Setting item <input type="text"/>	Mode <input type="text"/>	Interval <input type="text"/>	Duration <input type="text"/>
Transmission	Interval	3600 s	Continuously s

## Edge Intelligence setting template for flight period

The ODBA values calculated from the raw tri-axial acceleration data and can clearly indicate the activity intensity change rhythm of the organisms. Combined with other information, users can make a rough judgment of animal behaviour.

Therefore, based on the change of ODBA value to adjust the working mode of the device, can help users to capture some behaviour of attention, especially when the device cannot get the ideal energy supplement, based on specific conditions trigger multistage frequency conversion can strategically tilt for energy use, play the best use value of limited energy.

- Basic Setting
  - GNSS interval: 7200 s (adjustable according to device battery)
  - ENV interval: 7200 s (adjustable according to device battery)
  - ODBA interval: 600 s (adjustable according to device battery)
  - Transmission interval: 28,800 s (adjustable according to device battery)
- Edge Intelligence Setting

Rules	Condition			Action	
Rule 1	and	Voltage> 3.9	NA	GNSS 1h	ODBA 5min
Rule 2	and	ODBA>5,000	Voltage> 3.85	GNSS 30min	ODBA 5min
Rule 3	or	ODBA>10,000	Speed> 4 m/s	GNSS 10min	ENV 3min

- Setting Demonstration for Rule 3



Rule name:  New Cancel

Condition [View help](#)

Condition relation:  and  or

<input type="checkbox"/>	Variety <input type="text" value="Activity"/>	Trigger <input type="text" value="Higher than"/>	Threshold <input type="text" value="10000"/>	Condition duration <input type="text" value="Start now"/> s	<input type="button" value="Delete"/>
<input type="checkbox"/>	Variety <input type="text" value="Speed"/>	Trigger <input type="text" value="Higher than"/>	Threshold <input type="text" value="4"/> m/s	Condition duration <input type="text" value="Start now"/> s	<input type="button" value="Delete"/>

Action [View help](#)

<input type="checkbox"/>	Activate after <input type="text" value="Once immediately"/> s	Setting item <input type="text" value="GNSS collecting"/>	Mode <input type="text" value="Interval"/>	Interval <input type="text" value="600"/> s	Duration <input type="text" value="Continuously"/> s	Expected transmission time (Timezone UTC+0) <input type="text" value="2023-06-23 07:30:00"/>	<input type="button" value="Delete"/>
<input type="checkbox"/>	Activate after <input type="text" value="Once immediately"/> s	Setting item <input type="text" value="Environment collect..."/>	Mode <input type="text" value="Interval"/>	Interval <input type="text" value="300"/> s	Duration <input type="text" value="Continuously"/> s		<input type="button" value="Delete"/>

## Why is the data not updated?

Please click [here](#) to get more information.

## Will data stop updating if my billing account is overdue?

Druid attaches great importance to users' data and will never stop the data updating of any devices without prior notice.

If your device stops data updating, please click [here](#) to get more information.

## What do different colors of device number and icons mean?

The device number and icons are as follows:

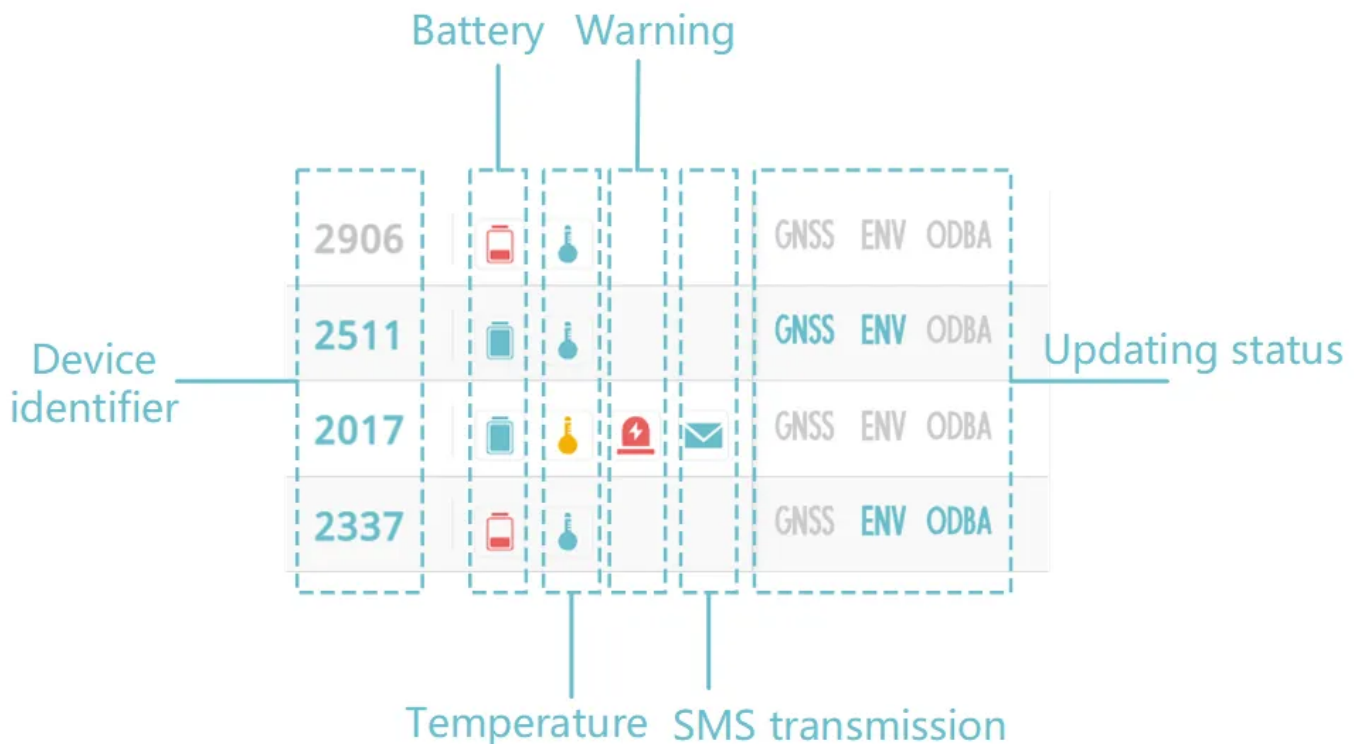

- Device identifier

Ecotopia data center uses 3 different colors of device identifier to indicate different data subscription status:



- Green: **Active**
- Blue: **Inactive**
- Grey: **Suspended**

For more information on data subscription status, see [Data subscription status and data service items](#).





- Battery

Ecotopia data center uses different colors of battery icon to indicate different voltages:  
For FLEX and LEGO:

-  icon indicates that the voltage of the device battery is higher than or equal to 3.95 V.









-  icon indicates that the voltage of the device battery is higher than or equal to 3.8 V and is lower than 3.95 V.
-  icon indicates that the voltage of the device battery is lower than 3.8 V.
-  icon indicates that the voltage of the device battery is unknown.

For OMNI, MINI and NANO:

-  icon indicates that the voltage of the device battery is higher than or equal to 4.0 V. -  icon indicates that the voltage of the device battery is higher than or equal to 3.9 V and is lower than 4.0 V. -  icon indicates that the voltage of the device battery is lower than 3.9 V. -  icon indicates that the voltage of the device battery is unknown.

- Temperature

Ecotopia data center uses different colors of temperature icon to indicate different temperature ranges:

-  icon indicates that the temperature of the environment where the device is located is higher than or equal to 60°C.
  -  icon indicates that the temperature of the environment where the device is located is higher than or equal to 30°C and lower than 60°C.
  -  icon indicates that the temperature of the environment where the device is located is higher than or equal to 5°C and lower than 30°C.
  -  icon indicates that the temperature of the environment where the device is located is higher than or equal to -5°C and lower than 5°C.
  -  icon indicates that the temperature of the environment where the device is located is lower than -5°C.
  -  icon indicates that the temperature of the environment where the device is located is unknown.
- Warning  
If the ODBA of the device has been low for three consecutive hours when the device communicates with the server for the last time, icon  is displayed to indicate that the animal wearing the device may be dead, or the device may have fallen from the animal. The  icon is usually displayed for an undeployed device because a device is usually still during the test. When the device is deployed and data is updated, the  icon will be gone automatically.

**Note:** A warning indicates a highly possible death or device fall, which may need [further analysis](#) to confirm.

- SMS transmission

If the device transmits the data via SMS for the last time, icon  is displayed. If not, this icon is not displayed.

- Updating status

Updating status shows the status of GNSS data (GNSS), Environment data (ENV) and ODBA with green and grey color.

- GNSS

If the latest GNSS data is valid and the interval between the GNSS collecting time and the latest transmitting time is less than or equal to 30 minutes, the icon is green. Otherwise, it is grey.

- ENV

If the interval between the latest ENV collecting time and the latest transmitting time is less than or equal to 30 minutes, the icon is green. Otherwise, it is grey.

- ODBA

If the interval between the latest ODBA collecting time and the latest transmitting time is less than or equal to 30 minutes and the user has subscribed ODBA, the icon is green. Otherwise, it is grey.

## Why error occurs during data downloading?

There are two possible causes.

1. Existing download result inconsistent with new download workflow.

After data downloading, the data download link of a device during a period is listed in **Download > Result**. Since we have updated the download workflow, when you download data of the device of the same period for the second time, inconsistency happens, and error may occur. In this case, go to **Download > Result** and you will see a pop-up window. Click **Clear cache and close** and then try downloading again.

2. Connection incompatibility with a few ISPs (Internet Service Provider).

Users of most ISP don't have this problem. However, error may occur for some of them due to connection incompatibility. This will be less a problem as our cloud service provider are compatible with more and more ISPs. In this case, try to use the internet service provided by another ISP.

If error still occurs, please contact us.

## Why is the download link blank or missing after the download is complete?

Please refer to [Downloading data](#) for more information.



## What is the meaning of each field in the downloaded CSV data?

For the explanation of the field in the downloaded CSV data, please refer to [CSV field explanation](#)

## Why does one obvious GNSS error occurs sometimes?

Sometimes one obvious GNSS error occurs among all the reasonable GNSS fixes because of "static drift", an inherent feature of GNSS. It means when a GNSS terminal is stationary, its positioning is often changing, which can be caused by being under a roof, near tall buildings and walls, close to water surface or in a magnetic field. Such drift often happens during test. It happens much less in dynamics or after deployment.

# What's the accuracy of GNSS fixes by DEBUT devices?

Two terms are mentioned when talking about GNSS accuracy.

- DOP (Dilution of Precision), a value to describe the effect of geometry of used satellites on GNSS positional measurement precision. According to [past researches](#), it is an effective way to screen GNSS data or can be set to improve GNSS accuracy.
- CEP (Circular Error Probable), which is defined as the radius of a circle, centered on the actual location, whose perimeter is expected to include 50% of the GNSS fixes.

1. For DOP, you can download GNSS data from Ecotopia data center and refer to HDOP (Horizontal Dilution of Precision) and VDOP (Vertical Dilution of Precision) field of a certain piece of GNSS data.

**Note:** Some older devices, such as FLEX and some models of LEGO, do not use HDOP and VDOP to indicate the GNSS accuracy. For those devices, you can refer to HorAccuracy and VerAccuracy in the downloaded GNSS data file.

2. For CEP, both chip test data by chip manufacturer and device test data by us are offered below for your reference.

- Chip Test Data by chip manufacturer

Prerequisite:

- GNSS signal strength is over -130 dBm
- Number of connected satellites is more than 6
- Chip works at the frequency of 1 GNSS fixes per second for 24 hours in static state

Test result: - Horizontal positioning accuracy: CEP (50%) 2.5 m, meaning that 50% of the GNSS fixes falls within a circle with a radius of 2.5 m - Vertical position accuracy: not provided. According to [past researches](#), on average the vertical or altitude error is 1.5 to 3 times greater than the horizontal error.

- Device Test by us

We have been doing device test on GNSS accuracy in various environments. Below are 2 examples:

For devices somewhere in downtown area of Chengdu, China, the accuracy is from 50% within 5m to 85% within 10m.

For devices somewhere in Sanjiang Plain, China, the accuracy is from 85% within 5m to 98% within 10m.

The above mentioned testing was done in an ideal environment. In actual use of the device, there are many factors that can impact GNSS accuracy. For more information, see [Why does one obvious GNSS error occurs sometimes?](#)

## Why is GNSS data sometimes blank?

When GNSS positioning fails, you can see a - mark in the **Latest Location** column of the device.

Transmitting time	Collecting time	Latest Location
2021-06-29 11:28:42	2020-06-28 18:53:57	30.5497248,104.0596416
2021-06-29 11:18:22	-	-
2021-06-29 05:10:12	2021-06-29 00:41:54	51.6606528,22.720824
2021-06-29 05:10:04	2021-06-29 03:04:26	30.5508064,104.0592448

Also, when you check the GNSS data detail in Ecotopia App or check the downloaded GNSS data, you can see the values of Longitude and Latitude are both 200.00000.

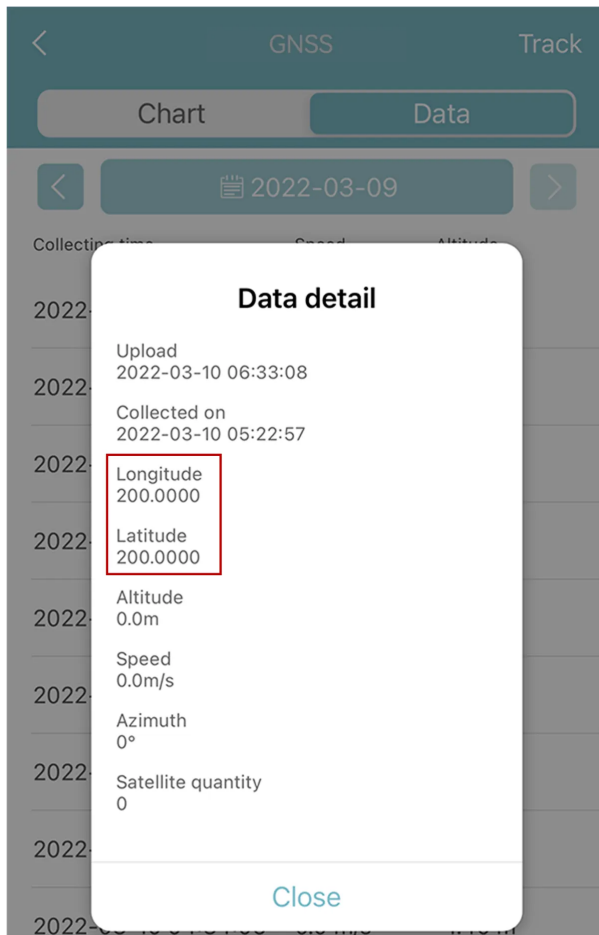

The main reasons for positioning failure include:

- Poor GNSS signal

Dense forests, strong magnetic fields, being close to open waters , etc. can cause GNSS signal blocking or interference, and leads to positioning failures.

- Antenna Damage

The external antennas of some models or even GNSS modules are broken due to force majeure like bird's pecking or predators, etc..

# What is ODBA?

ODBA is short for Overall Dynamic Body Acceleration. It is a new acceleration index which quantifies the three-dimensional movement of animals as the value of acceleration and is assumed to be a proxy for activity-specific measurement and has been used in the field of wild animal ecology.

DEBUT devices are equipped with a high-precision 3-axis accelerometer that continuously collects raw acceleration data at a sampling rate of 25 Hz. Leveraging an embedded algorithm, the device automatically processes this continuous stream of raw acceleration data and calculates and outputs ODBA values at user-defined intervals.

For instance, if the user sets the ODBA interval to 10 minutes, the device will intelligently compute and output an ODBA value every 10 minutes. This ODBA value serves as a comprehensive metric, accurately reflecting the overall movement and activity levels exhibited by the animal during the 10-minute period.

To know more about how ODBA is calculated, please refer to the following 2 papers.

*Wilson RP, White CR, Quintana F, Halsey LG, Liebsch N, Martin GR, et al. Moving towards acceleration for estimates of activity-specific metabolic rate in free-living animals: the case of the cormorant. J Anim Ecol. 2006;75(5): 1081–90.*

*Qasem L, Cardew A, Wilson A, Griffiths I, Halsey LG, Shepard ELC, et al. Triaxial dynamic acceleration as a proxy for animal energy expenditure; should we be summing values or calculating the vector? PLoS One. 2012;7(2): e31187.*

To convert the unit of ODBA value to g, divide it by 10,000.

ODBA is unsubscribed by default. You can [subscribe](#) it if you need.

If you need to access the acceleration raw data, refer to [How to obtain acceleration raw data?](#)  
[Can I set the collecting interval?](#)





## How to obtain acceleration raw data? Can I set the collecting interval?

Now there are two ways to obtain the acceleration raw data:

1. You can use Ecotopia App to obtain real time acceleration raw data using INTELINK. The obtained data will be stored to your mobile phone. For more information, see [Data tagging](#).
2. DEBUT devices collect the acceleration raw data according to the settings and save the data to the device storage, then transmit the data to our cloud server through INTELINK, cellular network or satellite.

The sensor we use to collect the acceleration data is 3-axis accelerometer with a collecting frequency of 25 Hz, which means that each axis will collect 25 pieces of data per second. Since the sensitivity of the 3-axis accelerometer is affected by the temperature, the actual collecting frequency varies from 24 Hz to 26 Hz. To avoid a large burden on data storage and transmission, the 3-axis accelerometer usually collects data in interval mode. The minimum collection interval is 1.5 seconds / minute. For example:

- If the collecting interval is set to 1.5 seconds / minute, each of the 3 axes collect 36 ~ 39 pieces of data every minute. In 24 hours, the 3-axis accelerometer can generate over 160,000 pieces of data. With this setting, the device can store the acceleration raw data for about 10 days.
- If the collecting interval is set to 3 seconds / 10 minute, each of the 3 axes collect 72 ~ 78 pieces of data every minute. In 24 hours, the 3-axis accelerometer can generate over 30,000 pieces of data. With this setting, the device can store the acceleration raw data for about 50 days.

As you can see, the 3-axis accelerometer can generate a huge amount of data if not set properly and thus can put excessive pressure on the data storage, data transmission and energy consumption of the device. Therefore, the acceleration raw data related settings are not available on user center and app. If you do have the needs to adjust the setting, please contact [support@druid.tech](mailto:support@druid.tech).

Note: DEBUT devices store acceleration raw data in a separate sector, which does not affect the storage of other data.



## How can I know the direction of X/Y/Z axis of ACC data as represented on a device?

The actual direction of the three-axis accelerometer varies for different devices. You can use the data tagging feature of INTELINK to determine the direction of the three axes. If your devices do not support INTELINK, contact us for more information.

1. Go to Data tagging page using INTELINK.

For detailed procedure, see [Data tagging](#). After it is done, you can see three of the signal lines with the blue one representing X axis value, green one representing Y axis value and red one representing Z axis value, as shown below.

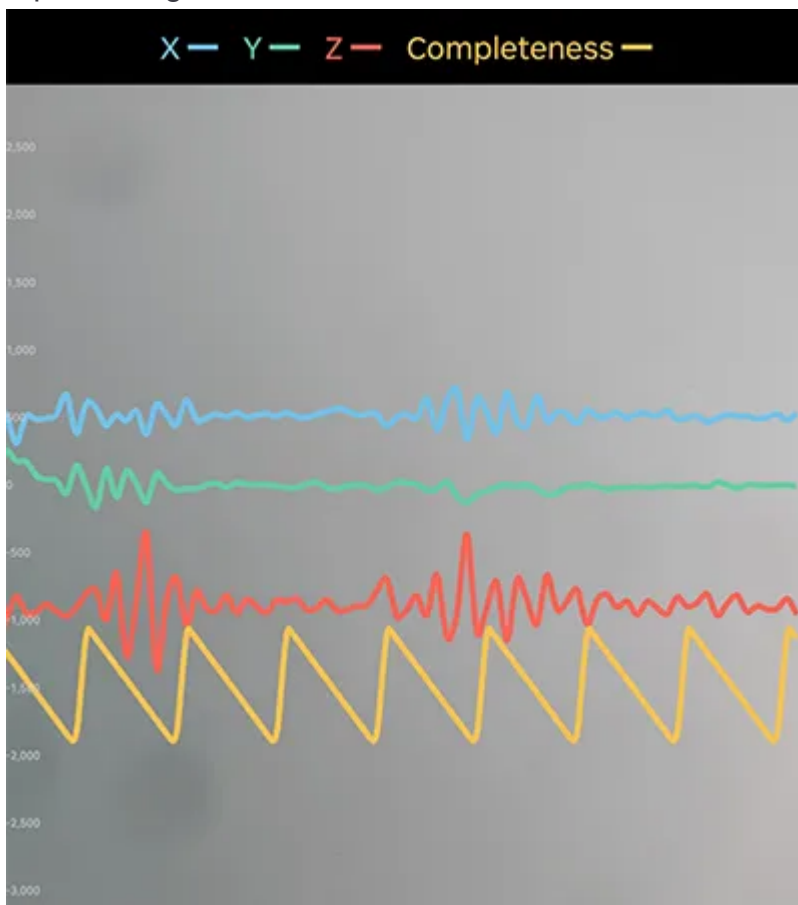

2. Place device in different directions and observe X/Y/Z value.

When the value of an axis is close to +1000 or -1000, the direction of the axis is parallel to the gravity. And a positive value means a direction opposite to the gravity while a negative value means a direction the same as the gravity.

Example:

- Place NANO on a stable place as below.

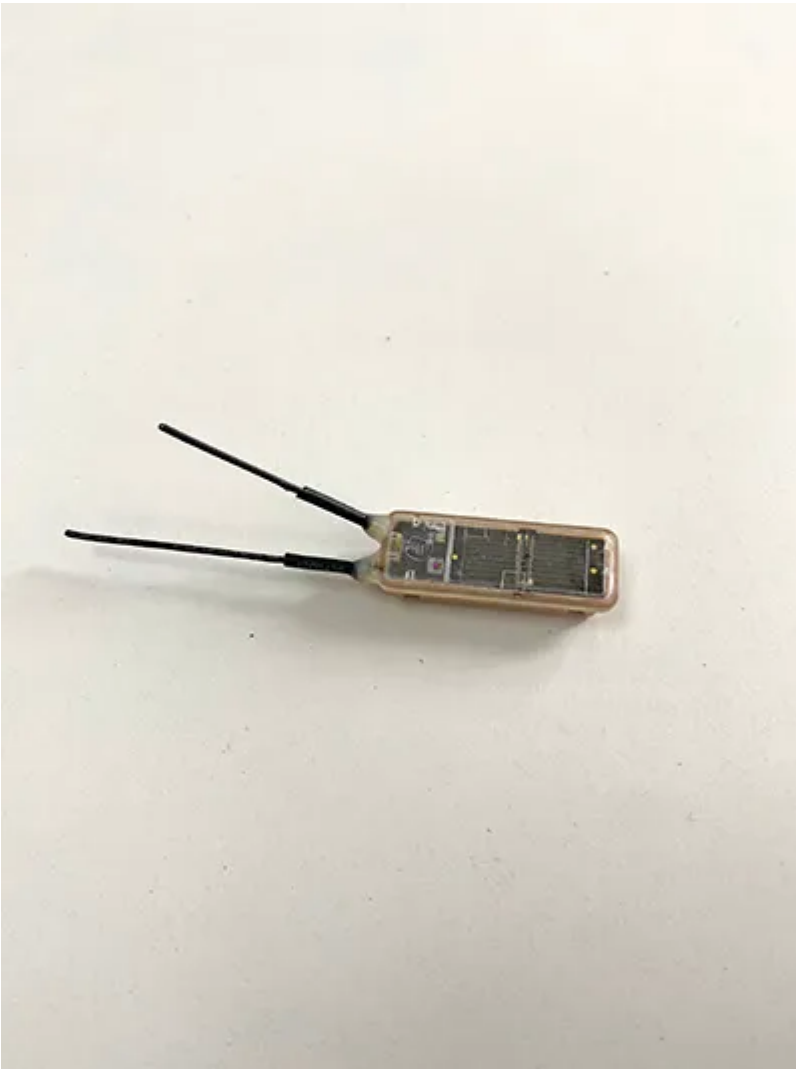

Value Z is close to -1000



- Place NANO on a stable place as below.



Value Y is close to 1000

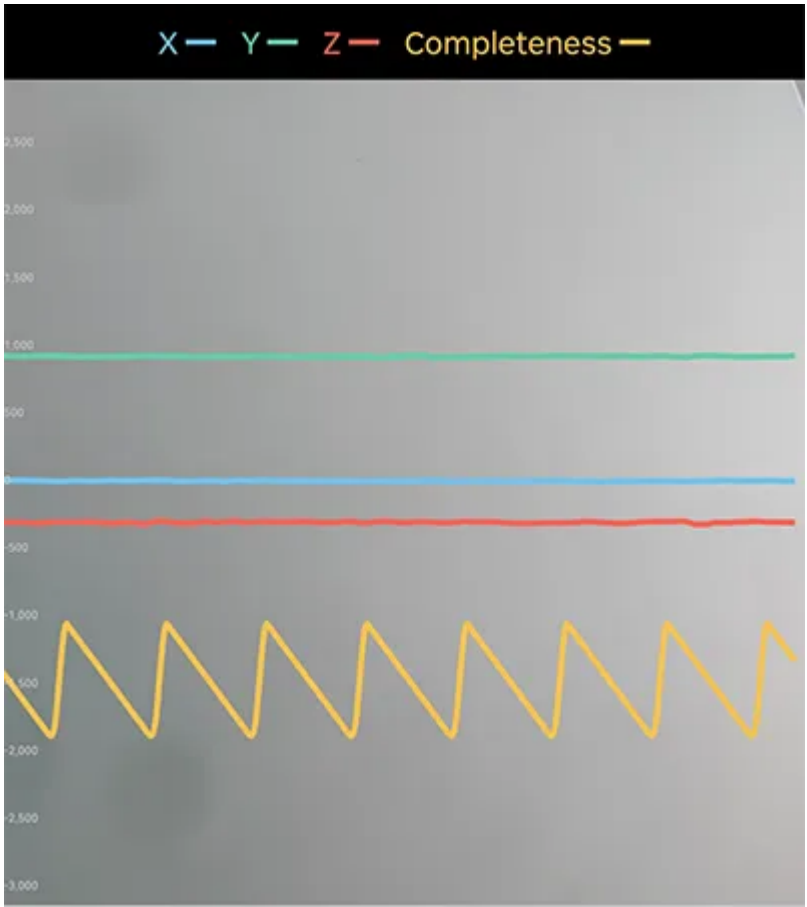

- Place NANO on a stable place as below.



Value X is close to 1000



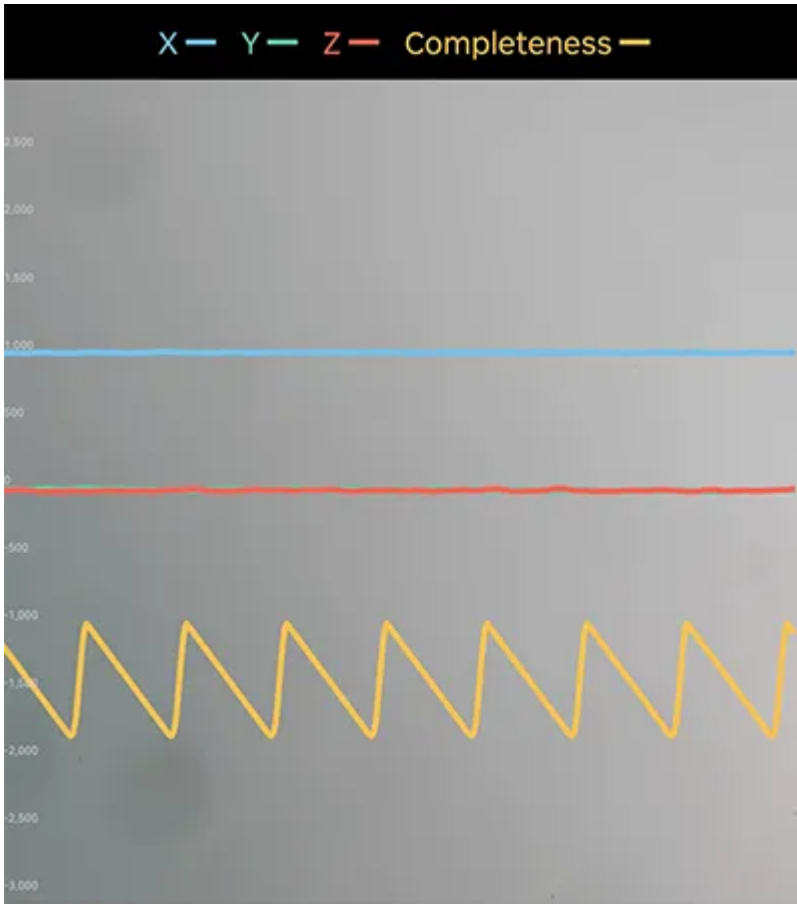

So we can get that the direction of the three axes in the device is illustrated as below:

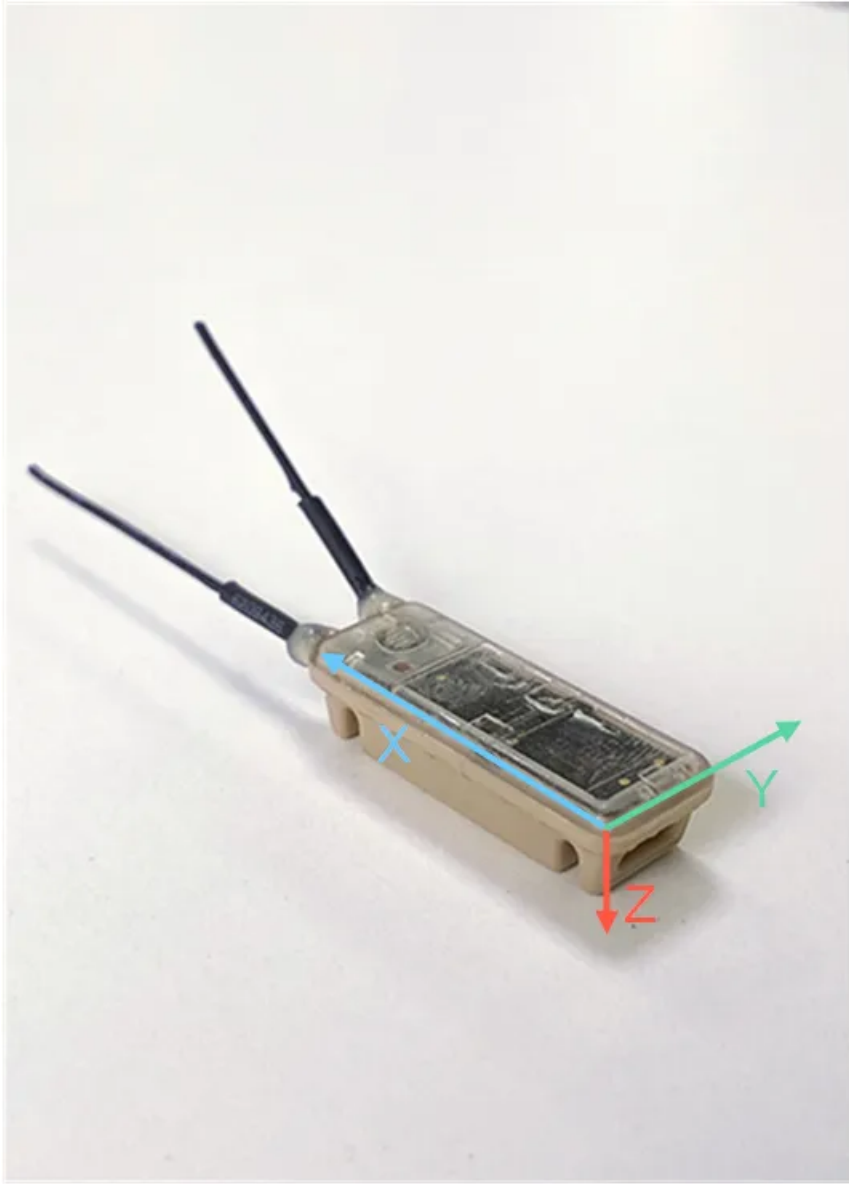

## Is the data downloaded from data center preprocessed?

All of the data you download from Ecotopia data center has not been processed in any way. Please note that only ODBA is an exception. ODBA is a value uses the algorithm to quantify the data collected by the accelerometer into an indicator that can express the intensity level of animal activity.

In future, we will launch our algorithm platform. You will be able to import your algorithm to the platform and use the data collected by DEBUT devices to verify, train or adjust the algorithm.

## What is Beacon data and Proximity data?

**Beacon data** is displayed on the page of a [terminal device](#) to show when the terminal device enters or exits the INTELINK range of different gateway devices.

When a terminal device enters the INTELINK range of a gateway device, the terminal device will use the GNSS info of the gateway device instead of its own GNSS data before it exits. And no GNSS data is collected during the period.

Note that Beacon data is **Off** by default.

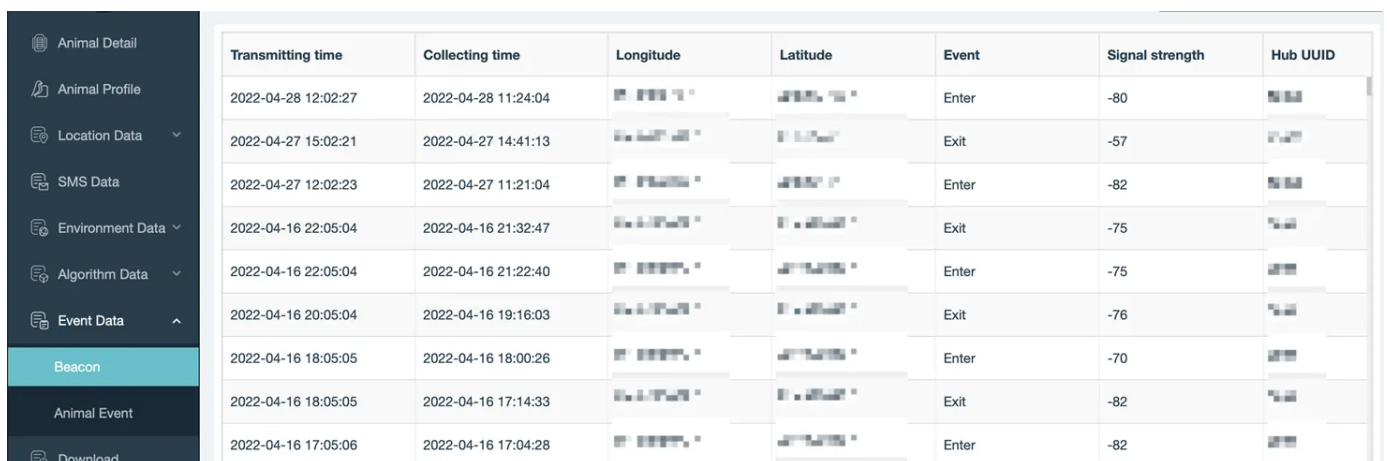

Transmitting time	Collecting time	Longitude	Latitude	Event	Signal strength	Hub UUID
2022-04-28 12:02:27	2022-04-28 11:24:04	113.928111°E	39.905111°N	Enter	-80	78168
2022-04-27 15:02:21	2022-04-27 14:41:13	113.928111°E	39.905111°N	Exit	-57	78168
2022-04-27 12:02:23	2022-04-27 11:21:04	113.928111°E	39.905111°N	Enter	-82	78168
2022-04-16 22:05:04	2022-04-16 21:32:47	113.928111°E	39.905111°N	Exit	-75	78168
2022-04-16 22:05:04	2022-04-16 21:22:40	113.928111°E	39.905111°N	Enter	-75	78168
2022-04-16 20:05:04	2022-04-16 19:16:03	113.928111°E	39.905111°N	Exit	-76	78168
2022-04-16 18:05:05	2022-04-16 18:00:26	113.928111°E	39.905111°N	Enter	-70	78168
2022-04-16 18:05:05	2022-04-16 17:14:33	113.928111°E	39.905111°N	Exit	-82	78168
2022-04-16 17:05:06	2022-04-16 17:04:28	113.928111°E	39.905111°N	Enter	-82	78168

**Proximity data** is displayed on the page of a [gateway device](#) (for now) to show the device list within the INTELINK range of the gateway device at a certain time.

When you click into the device list, you can check the basic info of the terminal devices including battery level and ODBA, etc.

Note that Proximity data is **Off** by default.

## Why is there repetitive GNSS data and minor time deviation for Argos devices?

Sometimes you may find repetitive GNSS data for Argos devices and minor time deviation for each piece as shown below.

Synchronizing time	Collecting time	Longitude	Latitude	Altitude
2023-05-21 02:13:18	2023-05-21 08:01:18	141.2824889 °	42.2828284 °	157 m
2023-05-21 04:13:07	2023-05-20 22:01:21	141.2824872 °	42.2828418 °	175 m
2023-05-21 04:13:07	2023-05-20 21:01:18	141.2824788 °	42.2828128 °	155 m
2023-05-20 21:13:11	2023-05-20 15:01:34	141.2828134 °	42.2828284 °	85 m
2023-05-20 12:12:58	2023-05-20 09:00:40	141.: 968 °	42. 152 °	213 m
2023-05-20 10:13:18	2023-05-20 08:59:49	141.: 968 °	42. 152 °	213 m
2023-05-20 10:13:18	2023-05-20 07:00:48	141.2819872 °	42.2811888 °	138 m
2023-05-20 12:13:08	2023-05-20 07:00:42	141.2819872 °	42.2811888 °	138 m
2023-05-20 10:13:18	2023-05-20 07:00:48	141.2819872 °	42.2819872 °	147 m
2023-05-20 10:13:18	2023-05-20 07:00:44	141.2819872 °	42.2819872 °	147 m
2023-05-20 10:13:18	2023-05-20 07:00:42	141.2819872 °	42.2819872 °	147 m

As for data repetitiveness, you can find the reason by clicking [here](#) to know how does it happens.

As for minor time deviation, it is because the collecting time (of an Argos device) is a relative time with an accuracy of 1 minute. When a piece of data is transmitted for the second time, there will be a time deviation within 1 minute. It is not an error, and you can choose either one piece of the data.

# What does a user need to do before using an Argos device from Druid?

To use Druid's Argos devices, Argos satellite service is needed. Your research program needs to be approved and each device is identified by a specific ID number.

As required by CLS, the unique operator of the Argos system, a user needs to contact CLS directly for Argos satellite service. Accordingly, we have made a workflow to facilitate this process. Below are the steps a user needs to do before using Druid's Argos devices.

## Step 1: Apply for an Argos program on [CLS's website](#)

1. Click on the **Register** button.

### Become an Argos User in Just 4 Steps

Joining the Argos community is easy, and our experts are on hand to help you every step of the way.



#### Register Online

Please start by completing this online form so that we can better understand your project and needs.



2. Fill in the contact information for the program's administrator, check the **I'm not a robot** checkbox and then click **Next**.

New program registration

Last name:  First name:

Organization:  Department:

Address:

Zip Code:  City:

State/Province:  Country:

I'm not a robot 

3. Fill in the specific information of your research program.

- Program name - provide a name for the project (e.g., Gulf Sea Turtle Project).
- Deployment date - select one month before your tags are scheduled to be shipped from Druid.
- Type of Argos application - select “Wildlife”.
- Duration (in months) - enter the longest duration possible for your application. This will become your program’s expiration date.
- Planned number of platforms - enter the number of PTT IDs you need for your program. You need one PTT ID per device.
- User requirements - this field is for CLS information purposes only. It has no bearing on what data or services you will receive. You can select as many as you want. Druid recommends checking the following boxes:
  - Global coverage
  - Location accuracy
  - Low transmitter power (< 1 watt)
- Detailed description of the program objectives.

New program registration

Name:  Deployment date:

Type of Argos application:  Planned number of platforms:

Duration (in months):

Polar coverage  Global coverage  Location accuracy  Test and evaluation (manufacturer only)

Data throughput time  Low transmitter power (< 1 watt)  Transmitter small size and light weight  Cost effectiveness (government users only)

Service continuity and reliability  Platform compatibility  System access  Dual GPS/Argos location

Other, please specify:

Detailed description of program objectives:

4. Fill in additional information on the program and the organization and click Next.

5. Choose NO because your Argos IDs are bonded with your devices, and the Argos IDs will be added to your program by CLS when your devices are ready.

#### New program registration

CLS is the only organization authorized to allocate Argos ID numbers. Each platform is identified by a specific ID number used for accurate system processing. These ID number(s) will be requested and integrated by your platform manufacturer.

- YES : Continue with Argos registration and fill out the technical file now       NO : Send Argos registration request (SUA), but fill out the technical file later.

6. Wait for CLS to contact you and send you program number and Argos account for consulting your results on line. If your application is urgent, or if you have not received confirmation of your application after several days, we recommend contacting CLS to confirm that your information has been received.

## Step 2: Create a guest account & send necessary info to Druid

As most users will use their Argos IDs for different projects, we recommend that you create a guest account for each project and allocate the required quantity of IDs into this guest account. The procedure is below:

1. Click [here](#) to log in with Argos account.
2. On the home screen, click on the profile icon in the upper right corner to reveal **My Account details**, and then click **Guest account**.

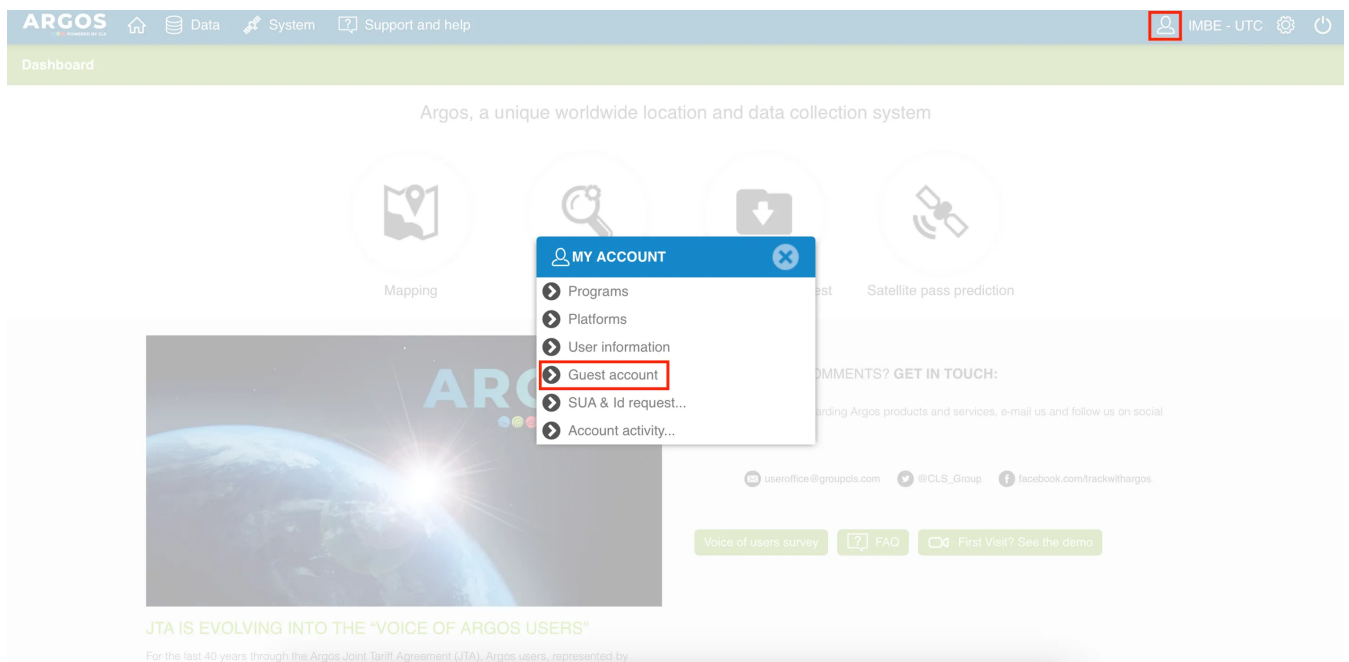

3. Click on the + sign in the upper-right-hand side of the screen to create a guest account. For the name of **User**, it is suggested to write this way to avoid possible confusion or mistakes during Argos ID assignment: initials or part of your organization or project name\_ initials or part of your name. For example, **Druid\_Cain** or **DT\_SGD**.





Note that when the Expiry date is due, your Ecotopia account won't be able to get data updates anymore. Please consider and set a proper Expiry date according to your need. It is suggested to set a date 2~3 years from present date.

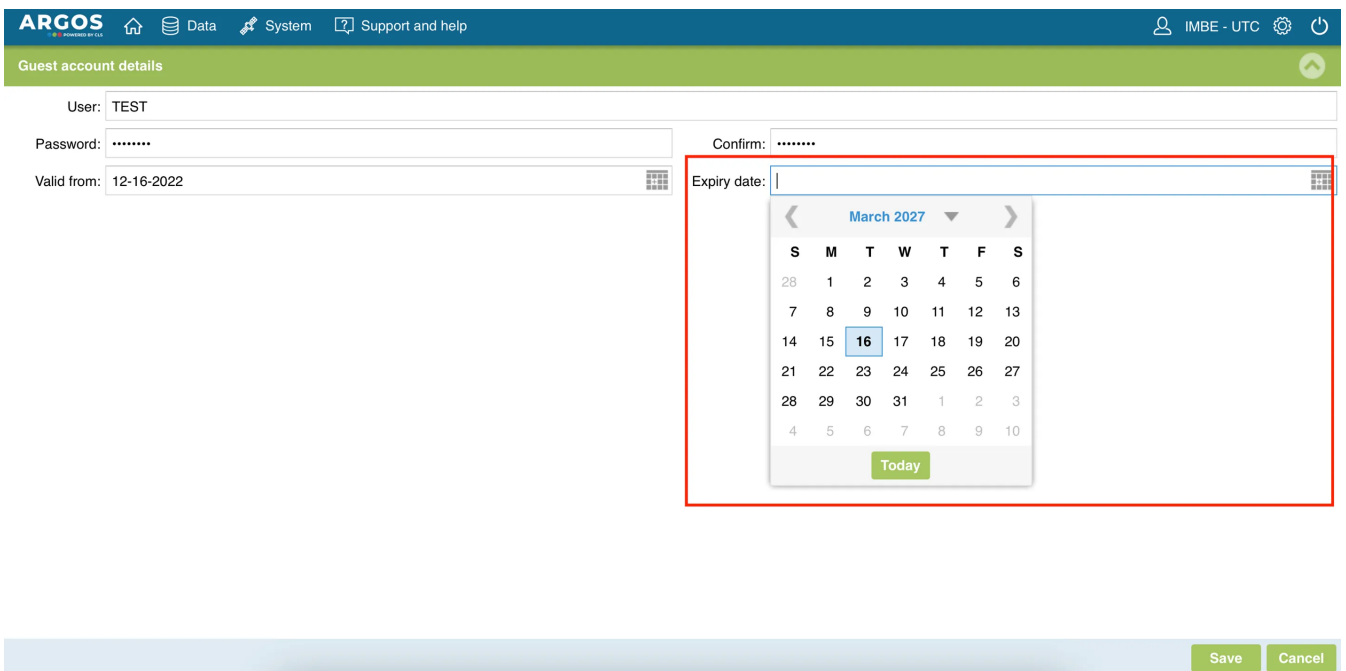

Click **Save** and the new guest account will be added.

4. Provide the following info to your sales representative from Druid via email.

- Program info including Argos program number, species and repetition rate.
- Guest account username and password.

### Step 3: Allocate Argos IDs to the guest account

Wait for notification from your sales representative to allocate Argos IDs to the guest account.

1. On the home screen, click on the profile icon in the upper right corner to reveal **My Account details**, and then click **Guest account**.

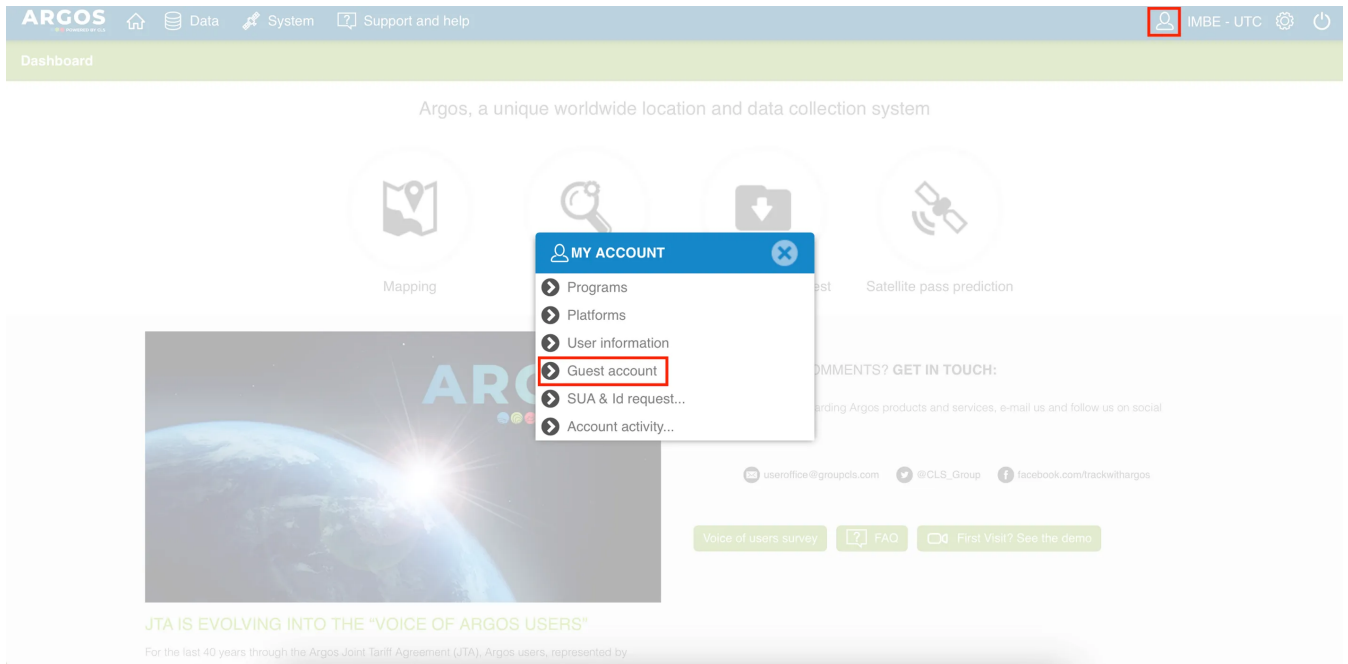

2. Click the pencil icon before the guest account to display two options: **Available programs** and **Available platforms**.

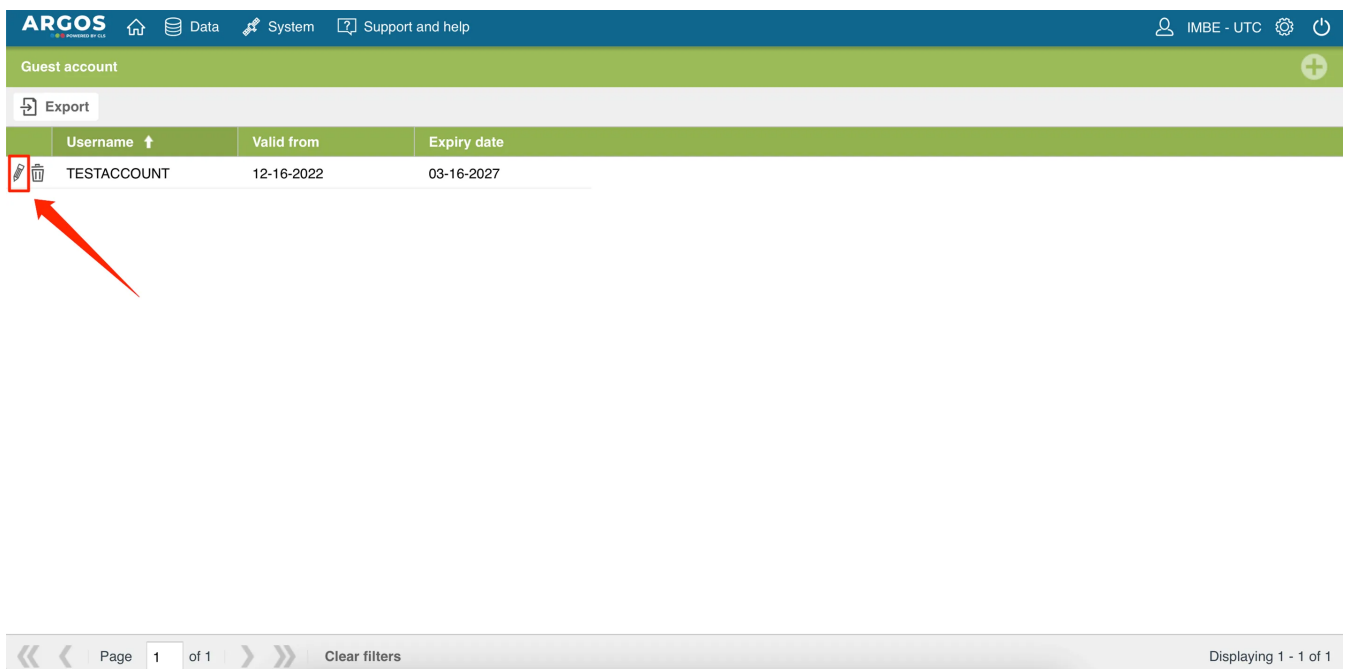

Click the + sign on the right side of **Available platforms**.

ARGOS Home Data System Support and help IMBE - UTC Settings Power

**Guest account details**

User: TESTACCOUNT  
 Password: ..... Confirm: .....  
 Valid from: 12-16-2022 Expiry date: 03-16-2027

**Available programs**

Number ↑	Name	Person in charge	Organization	Copy start	Copy end
----------	------	------------------	--------------	------------	----------

**Available platforms**

Number ↑	Name	Platform type	Model	Program number	Person in charge
----------	------	---------------	-------	----------------	------------------

Save Cancel

Select the IDs as instructed by your sales representative, and click **Add** and then **Save**.

ARGOS Home Data System Support and help IMBE - UTC Settings Power

**Guest account details**

User: TESTACCOUNT  
 Password: ..... Confirm: .....  
 Valid from: 12-16-2022

**Available programs**

Number ↑	Name	Copy start	Copy end
----------	------	------------	----------

**Available platforms**

Number ↑	Name	Program number	Person in charge
----------	------	----------------	------------------

**Add platform**

Copy start:  
 Copy end:

**Select platform IDs**

Search items...

Value ↑
<input checked="" type="checkbox"/> [Item]
<input checked="" type="checkbox"/> [Item]
<input type="checkbox"/> [Item]

Ok Cancel

Save Cancel

Now you are ready to use Druid's Argos devices.

CLS is the only organization authorized to allocate Argos ID numbers. Each platform is identified by a specific ID number used for accurate system processing. These ID number(s) will be requested and integrated by your platform manufacturer.

Note that CLS collects Argos transmission fee separately. CLS's value added services for Argos including ArgosDirect and ArgosArchive are not necessary for normal functioning of Druid's devices. You can choose them based on your needs.



# How does Druid's Argos-GPS device work?

Classic Argos PTTs provide global doppler locations, of which the accuracy varies between several hundred meters to several kilometers. GPS locations enjoy much better accuracy.

Different from Doppler method, GPS collects location data independently, meaning that the GPS data schedule is not related to Argos transmission.

To better understand the device functions, we need to bear in mind some features of the Argos system:

1. Argos transmission capacity is limited. When a device enjoys sufficient power supply (big battery or good solar charging), it is able to collect hundred pieces of GPS data per day, which is overwhelming for Argos transmission.
2. Argos transmission relies on satellite pass, and satellite pass timing varies with latitude. The higher the latitude, the longer the satellite pass periods, thus the more chance for data reception. This means the devices for migrating species should not use a fixed Argos transmission schedule.
3. Argos satellite reception can be notably affected by weather (e.g., thick cloud could lead to more transmission failures). This means the Argos transmission can fail even during satellite pass period.
4. Argos satellite will not tell the device whether a piece of data is successfully received or not.

Given the above ground, Debut series Argos-GPS devices are designed with a scheme described below for researchers to maximize the valid data reception without jeopardizing the device energy balance.

1. The device is able to use its latest GPS locations to predict Argos satellite pass. When the timing arrives, the device will make continuous transmissions to the satellites.
2. The device has an advanced setting called "GPS data queue" which is to help you get more evenly distributed GPS data.

For example, you set the device to collect GPS every hour, while at your latitude, the Argos

satellite pass happens during 1:10 pm ~ 2:50 pm and 9 pm ~ 11 pm. And you set the GPS data queue to **8**.

In this situation, when the first satellite pass happens at 1:10pm, the latest 8 pieces of GPS data, which should be 6 am, 7 am, 8 am, 9 am, 10 am, 11 am, 12 am and 1 pm, will enter the transmission queue. The device will attempt to transmit the GPS data, one at a time and repeatedly, to the Argos satellites.

Such data queue setting makes sure that the data collected during the blank period (when there's no satellite pass at all) can also have chances to be received.

With appropriate settings and good solar charging conditions, we have seen a lot of our Argos devices uploading over 40 valid GPS points per day at 38° latitude.

## Why are there discrepancies between location data on the Argos platform and Ecotopia platform?

You may have noticed discrepancies in the location data of a device between the Argos platform and the Ecotopia platform:

- **Coordinates:** There are no instances where the coordinates of a single device match between the Argos platform and the Ecotopia platform.
- **Timestamps:** The timestamps for data downloaded from Ecotopia are consistent and follow a fixed GNSS interval. However, the timestamps for data from the Argos website do not show any recognizable pattern.

For Druid's GNSS/Argos models, the discrepancies between the 2 platforms arise from the different methods of data collection and transmission:

- **Ecotopia Platform:** The data is GNSS-based, collected at regular intervals via GNSS satellites, and then transmitted via Argos satellites. This results in regular timestamps for data under each transmission session.
- **Argos Platform:** The data is Doppler-based, generated from Argos transmissions instead of GNSS satellites. Since Argos transmissions depend on satellite passes, the intervals are irregular.

Click [here](#) to know more about how Druid's GNSS/Argos models work.

## Which time zone is used in data center and App?

The time zone displayed on data center and App is set on your own. You can view the current time zone at the top bar of data center.



If you need to change the time zone, you can change it as follows:

Data center: Go to **User Center > My Information** page to change the time zone.

App: Go to **User > Settings > Timezone** page to change the time zone.

The changed time zone will be applied to all places where the time is displayed, except for the downloaded CSV file. The time zone of the downloaded CSV file is always UTC+0.

### Tips

If you need to change the time zone of the UTC+0 time in the downloaded CSV file to another time zone, please use the following Excel formula:

```
=DATEVALUE (LEFT (B2, 10) ) +TIMEVALUE (MID (B2, 12, 8) ) ±TIME (n, 0, 0)
```

In the formula,  $\pm$  and  $n$  of  $\pm$ TIME (n, 0, 0) need to be modified accordingly.

For example, if you want to change UTC+0 time to UTC+8 time, modify the formula as:

```
=DATEVALUE (LEFT (B2, 10) ) +TIMEVALUE (MID (B2, 12, 8) ) +TIME (8, 0, 0)
```

If you want to change UTC+0 time to UTC-3 time, modify the formula as:

```
=DATEVALUE (LEFT (B2, 10) ) +TIMEVALUE (MID (B2, 12, 8) ) -TIME (3, 0, 0)
```



## What are Device number, UUID and Device ID?

- Device number is a 4-5 digit number serial generated based on the manufacturing sequence.
- UUID is short for Universally Unique Identifier, which is the true unique identifier for each device.
- Device ID is the last four digits/letters of UUID.

Both UUID and Device ID are printed on device housing or sticker.

For many years, we used Device number on our data platform to provide an easy way for users to refer to their devices. However, Device number cannot be printed on device, thus caused confusion when users are trying to identify their devices without using App.

To solve this problem, we update our data platform to gradually change to the UUID/Device ID display mode instead of Device number. For the transition period, Device number will still be available. We recommend that all users to change to the Device ID mode and use Device number as a reference when necessary.

To switch among device number, UUID and device ID, do the following:

- Ecotopia Data Center

In the device list, click the icon as shown below.



- Ecotopia App

In the animal list or device list, click the icon as shown below.

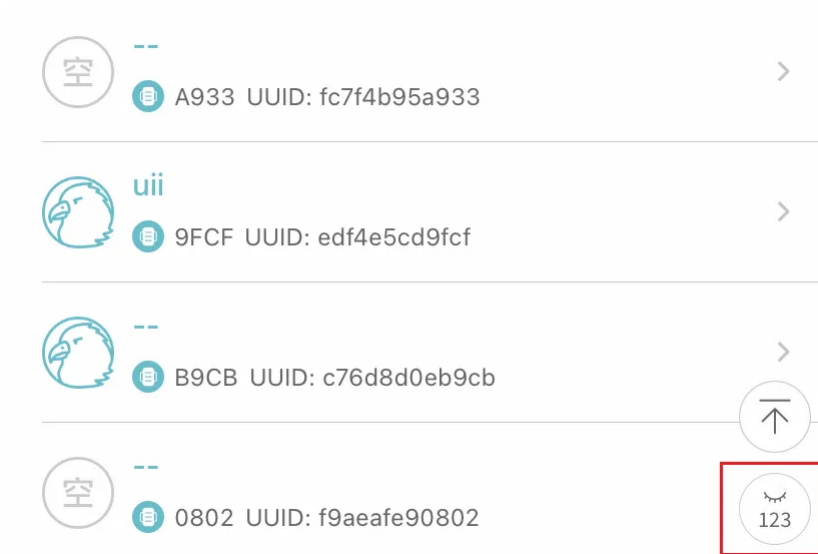

**Note:** In Ecotopia App, UUID is always displayed. So you can switch between device number and device ID.

To set the default display:

- Ecotopia Data Center
  1. On the main menu, click **User Center > My Information**.
  2. In the **Preferences** field, click **Device list display** drop-down list to select the default display.
- Ecotopia App
  1. Tap **User > Settings**.
  2. Tap **Device ID display** drop-down list to select the default display.

## Why is the last GNSS fix of a track for a day different from that for a month or a year?

When you generate the track for a day, data center displays all of the GNSS fixes of the track. However, when you generate the track for a month or a year, data center only displays the last successful GNSS fix of each day in the month or the year.

Some devices may not transmit data strictly according to setting sometimes (mostly because of poor network coverage). For Year and Month mode, as a result, the system is designed to check and include newly transmitted GNSS fixes at UTC 00:00 only on odd days (such as 1st July, 3rd July and 5th July, etc.). So, for Year and Month mode, only after that can you see the latest track.

For example, we are viewing track a device on 2021-09-23. The GNSS fix in red box is the last successfully transmitted GNSS fix. Under Day mode, the End is the GNSS fix in red box. However, under Year or Month mode, the End is the GNSS fix in green box, which was checked and included into the latest tracking route by system at exactly `2021-09-23 00:00:00`. The GNSS fixes transmitted after it will be checked and included by system at `2021-09-25 00:00:00`.

**德鲁伊科技**  
 Druid Technology

- <
- Animal Detail
- Animal Profile
- Location Data ^
- GNSS**
- Geo
- Base Station
- SMS Data
- Environment Data v
- Algorithm Data v

UUID: 
 MAC:

All Data v Path

Transmitting time	Collecting time	Longitude	Latitude
2021-09-23 00:03:31	2021-07-07 01:23:13	169.7390592 °	60.3248384 °
2021-09-23 00:03:31	2021-07-07 01:22:53	169.7359872 °	60.3273408 °
2021-09-23 00:03:31	2021-07-07 01:22:34	169.733248 °	60.3295552 °
2021-09-23 00:03:31	2021-07-07 01:22:13	169.7312512 °	60.33232 °
2021-09-23 00:03:31	2021-07-07 01:21:54	169.7292544 °	60.3345472 °
2021-09-21 00:08:13	2021-07-07 01:21:33	169.72832 °	60.3369216 °
2021-09-21 00:08:13	2021-07-07 01:21:12	169.7285632 °	60.3394304 °
2021-09-21 00:08:13	2021-07-07 01:20:54	169.7294976 °	60.3414656 °
2021-09-21 00:08:13	2021-07-07 01:20:33	169.7302272 °	60.3437888 °

Note: If you need to see all GNSS fixes of a device in a map, you can export the data to KML format and open it with Google Earth.

## Why some GNSS fixes of a track are missing under Month and Year mode?

When you generate the track for a day, data center displays all of the GNSS fixes of the track. However, when you generate the track for a month or a year, data center only displays the last successful GNSS fix of each day in the month or the year. So the maximum number of GNSS fixes on display is 365 for Year mode and 31 for Month mode.

Note: If you need to see all GNSS fixes of a device in a map, you can export the data to KML format and open it with Google Earth.

## What are the recommended adhesives for deployment?

Various adhesives may be required for device deployment. Below are some recommended options for different scenarios.

Scenario	Details	*Recommendation
Glue Deployment	Gluing a device directly to an animal's body	LOCTITE 454, LOCTITE 409
Knot Strengthening	Applying glue to tape knot to prevent it from unraveling	LOCTITE 401, LOCTITE 454, LOCTITE 409
Thread-locking	Applying adhesive to the bolt of mammal collars to prevent it from loosening	LOCTITE 243 if unscrewing is needed; LOCTITE 263 if unscrewing is not needed
Device Uplifting (Neoprene Pad)	Gluing neoprene pad to the device bottom to uplift the device to prevent feather coverage on solar panels	LOCTITE 454 or LOCTITE 409 for shorter cure time; 3M 5200 for longer cure time
Device Uplifting (*HIVE or Splitter)	Gluing a HIVE or a Splitter to a device to uplift the device to prevent feather coverage on solar panels	LOCTITE HY4090 for shorter cure time; LOCTITE 120HP for longer cure time
Adhesive Bonding	Gluing PCBA to battery for some XC and XF models	double-sided foam adhesive, silicone adhesive

\*For more detailed cure time, please refer to the adhesive instructions.

\*Gluing is not a must for HIVE, as tape goes through and secures it to prevent falling.



## Can the collar be removed from the main part after sliding in and locked?

The slide-lock structure is designed to make sure it won't fall from the animal after deployment.

If the device has already been deployed to an animal and needs to be removed for some reason, you can cut the collar part to avoid hurting the animal.

If the collar and the main part are connected and locked by accident, you can remove the collar from the main part with a hammer as shown below.



Note that, after being disassembled, the connecting part between collar and main part could be worn down and collateral damage may happen to the main part. So it is not suggested to deploy the device on another animal. However, if you have to, please test the device properly to make sure the device works fine (e.g. air tightness), and apply glue to the connecting part to secure it.





## What's the impact to DEBUT devices if my operator shuts down its 2G or 3G network?

If the relevant communication standard is completely closed in your country, the device can still collect data and store data in its memory. But it will not be able to transmit the data. Due to the different conditions in various countries, it is difficult for us to have accurate information. You must pay attention to the local policies to take proper actions.

According to our experience, operators usually spend several years to shut down a certain standard of network services, rather than shutting down immediately.

Please be noted that our devices have network roaming agreements in hundreds of countries and regions, and many birds make long-distance migrations across multiple countries or regions every year. The device may not be able to transmit data in one country, but it will transmit the stored data after flying to other countries. Even if the animal keeps staying in areas without 2G/3G network, you can choose to synchronize data via INTELINK from a distance or retrieving the device.

In addition, we are also developing and testing devices that use 4G or 5G (NB-IoT and eMTC) network. When 2G/3G network becomes unavailable for your device, you can use the Renewal Plan to upgrade your device to a new model.

## **Can I choose a specific telecom operator for my DEBUT devices?**

Yes. You can specify a telecom operator for your DEBUT devices with cellular module (2G/3G/5G). However, you need to apply for industrial level SIM cards on your own and send them to us before production. Make sure that the SIM cards can be used in mainland China so that the ex-factory test can be done.

Extra charges may be incurred for specifying a telecom operator. Please contact us before you apply for the SIM cards.

# How to confirm an animal death or device fall?

You will get a [warning](#) when an animal death or device fall is suspected, which, based on experience, can be confirmed if 3 or more of below conditions are met for data collected in the past week:

- ODBA stays below 100 ([ODBA subscription](#) needed).
- Acceleration remains unchanged ([ACC raw data subscription](#) needed) and movement speed remains at about 0.
- Animal movement range is within 25 m radius.
- Animal stays at abnormal locations like residential areas.
- Sharp rises or drops of temperature.
- Continuous drop of battery level.

## How to activate Debut Renewal Plan?

To activate Debut Renewal Plan, please follow below steps:

1. On data center, click **Device List** > **Terminal** and click any terminal to go to **Device Detail** page. The green shield icon



means you have already purchased Debut Renewal Plan for the device (grey color



means otherwise).

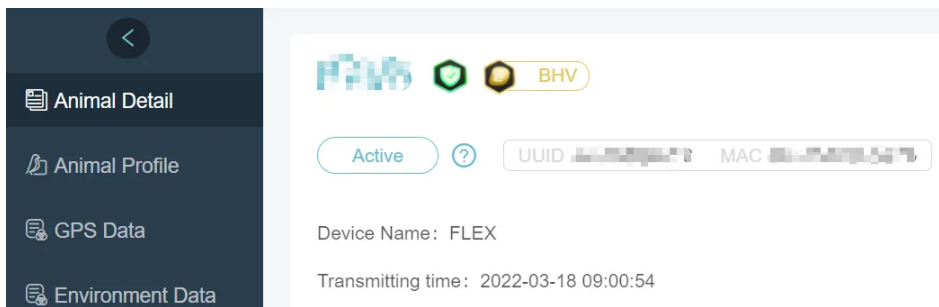

2. Click the



icon and follow the pop-up instructions to activate Debut Renewal Plan for the device.

Kindly note that the device will be automatically terminated when Renewal Plan is activated, meaning the device and all its history data will be erased from your account and can't be restored. So make sure that you have downloaded all history data before proceeding.

## Renewal Plan



This device is covered by the Renewal Plan.

This device will be automatically terminated when Renewal Plan is activated, meaning the device and all its history data will be erased from your account and can't be restored.

**Make sure that you have downloaded all history data before proceed!**

Enter "YES" to continue

Please contact [help@druid.tech](mailto:help@druid.tech) to prepare the replaced device for you.

Remark

3. Contact [help@druid.tech](mailto:help@druid.tech) to prepare the replaced device for you.

## Can data collected before deployment be hidden?

Yes. Click into a device and go to **Animal Profile** page. Set the deployment time and then data collected before deployment will be hidden (not deleted). Deployment time can be modified.

Note that you need to create an animal profile before setting the deployment time.

# How to use other users' HUB to collect data from your device?

There are two ways to do so.

1. To re-allocate the HUB to your account temporarily.

This way, we need an email approval from both of you.

Benefit: You can use the HUB the way as it is yours.

Disadvantage:

1. The historical data from the HUB will no longer be available on Ecotopia after each re-allocation (if no valuable data or the data has been saved locally, then no worries).
  2. The HUB might generate usage fee under your account (the billing is done every month).
2. To have the other users give you partial access.

This way, the other user will create a guest-account for you, and assign the HUB to it. So the HUB is still in their account, but you, after logging in to the guest-account, will be able to operate the HUB.

And also, the user needs to inform us to change the HUB to "super" mode so that the HUB can collect data from any DEBUT devices. Please note that the HUB in super mode cannot change setting or upgrade firmware for the devices that are not in its white list.



## Is it possible to enlarge the INTELINK/LoRa range of a HUB?

Yes, it is possible with the help of an antenna.

Below are the specification requirements of the antenna:

	Bandwidth (recommended)	Bandwidth (workable)	Input impedance
For INTELINK range	2400 MHz ~ 2480 MHz	2400 MHz ~ 2480 MHz	50 $\Omega$
For LoRa range	470 MHz ~ 510 MHz	150 MHz ~ 960 MHz	50 $\Omega$

### Note

- As LoRa frequency of a HUB can be modified, the recommended bandwidth for LoRa range should be the same as the setting. Please contact your sales representative for more information.
- To be connected to the HUB, the Yagi antenna should have a SMA plug (male pin and female thread) as the connector, as shown below:

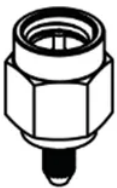

## What are terminal devices and gateway devices?

A terminal device collects data by itself while a gateway device collects data from other terminal devices and then transmits the data to the cloud server through base station, satellite, or mobile phone.

The devices deployed to animals are mostly terminal devices, while Debut HUB functions both as a terminal device and a gateway device.

## How does DEBUT HUB work?

Similar to other DEBUT devices, DEBUT HUB has the capability to collect and transmit GNSS data and environmental data, etc. Additionally, it incorporates two advanced features:

### 1. Smart Station Functionality

The HUB can function as a smart station when deployed in the field, a crucial feature for models relying solely on Intelink transmission, such as NANO. Once an animal equipped with a device enters the [Intelink range](#) of the HUB, the system seamlessly executes the following operations automatically.

- Download data from a device

The data will be downloaded immediately from the device to the HUB. The downloaded data is then uploaded to the server during the HUB's subsequent transmission session. After data download, if the device remains within the HUB's range, the HUB will "remember" the device and pause data downloading for a default set period to save power. In areas without a cellular network, all downloaded data is stored in the HUB's memory. You can move the HUB to an area with cellular coverage for automatic data upload during the next transmission session. Alternatively, you can download the data via the Ecotopia App to your phone from the HUB and upload it from your phone to the server using the phone's internet connection.

- Deliver settings to a device

After modifying the setting of a DEBUT device on the Ecotopia data center or App, the HUB will get the new setting from the server directly during its transmission session or indirectly when you [deliver the setting](#) to the HUB via the Ecotopia App. The new setting will then be delivered to the DEBUT device when the device enters the HUB's range.

- Record the enter/exit of a device (beacon data)

A HUB can detect a device's enter/exit of its range and keep a record as beacon data. If you need this feature, please contact us.

### 2. Mobile Relay Functionality

HUB can work as a relay to extend the connection distance between Ecotopia App and other DEBUT devices, making fieldwork more convenient. Click [here](#) to know how.

### Note

- For HUB to "recognize" devices and executes above operations to the devices, you must add the devices to the whitelist of HUB on Ecotopia. The white list info will be applied by the HUB in its upcoming transmission session or once you deliver settings to the HUB using the Ecotopia App. For more information, see [Adding terminal to HUB](#). No action is required for the devices.
- HUB can be set to Super Mode so that it can download data from all DRUID's devices. Other users will know about your kind help through a notification on Ecotopia. Please contact us to do the setting change for you.

The image below shows the data flow among DEBUT HUB, DEBUT devices and the server.

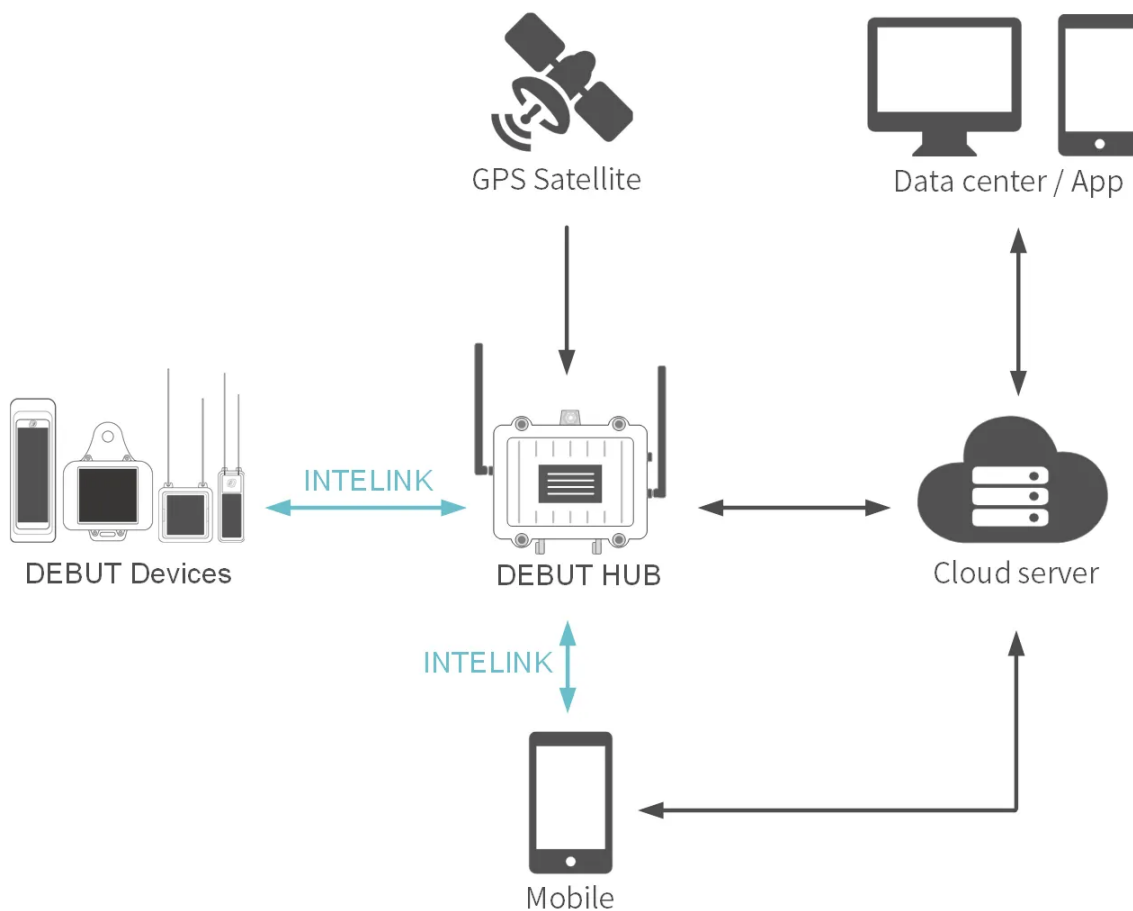

Please click [here](#) to get more information.

# What's the range of INTELINK?

The effective, reliable range between INTELINK devices is anywhere from more than a kilometer down to less than a meter.

NANO (BLE), as the representative model of INTELINK technology, has been optimized to enjoy a communicating range of up to 1500 m with HUB (a professional gateway) in ideal environments, enabling HUB to monitor any NANO that comes into the range and quickly download the valuable migration data from NANO.

Models like MINI (LoRa) has been embedded with both INTELINK technology and LoRa transmission ability. With a matching HUB, the communicating range could be a stable 5000 m.

Models with network or satellite transmission ability such as LEGO 3G and MINI Argos have an INTELINK range of only 30 m ~ 100 m. For such models, the INTELINK function is mostly for App remote operations, lost device finding, ACC raw data downloading and ODBA tagging, etc.

Some earlier models might not support INTELINK. Please consult your sales personnel for more information. If you have Renewal Plan, you can upgrade them to the latest version with INTELINK.

**Note:** INTELINK range varies with environment, because the obstacles between the transmitter and the receiver can deteriorate the signal strength. The attenuators can be anything from humidity and precipitation, to walls, windows, and other obstacles made of glass, wood, metal, or concrete, including metal towers or panels that reflect and scatter radio waves. When you are using INTELINK devices, please read the manual first to bring out the most of INTELINK potential distance.

**Abruption during last transmission due to weak network**

**Solution:** See [here](#).

[Back](#)

## Druid Technology

---

The external antennas of some models can be broken due to force majeure like bird's pecking or predators, etc. If you find that the GNSS failure lasts for a long period, you can use the renewal plan (if eligible) to get a new device.

[Back](#)

**Battery level is low (grey, red or yellow battery icon)**

**Solution:** Please wait for the battery level to resume and [adjust settings properly](#).

[Back](#)



### **Battery level is low (grey, yellow or red battery icon)**

**Solution:** BOOST needs a certain battery level to function. Please wait for the battery level to resume and [adjust settings properly](#).

[Back](#)

### **Battery level is low (grey, yellow or red battery icon)**

**Solution:** BOOST needs a certain battery level to function. Please wait for the battery level to resume and [adjust settings properly](#).

[Back](#)

**Battery level is normal (green battery icon)**

**Solution:** See [here](#).

[Back](#)

## Druid Technology

---

The device is already turned on, but the INTELINK connection is influenced by magnetic field or electric field, etc.

**Solution:** Please avoid interferences, place the device closer to mobile phone and try a few more times. If it still fails, please go to About us > Local log to [upload all local logs](#) and contact us.

[Back](#)

## Druid Technology

---

Possible causes are:

- [Low battery](#)
- [Signal interference](#)

[Back](#)

## Druid Technology

---

The device is located somewhere with GNSS signal interference or blocking like water surface or dense woods, under a roof or in a cave.

**Solution:** Please move the device to an open space with favorable environment and try again. If it is already deployed, please wait for the animal to move to a different place.

[Back](#)

## Druid Technology

---

Select your device type.

- [Device with cellular network transmission](#)
- [Device with INTELINK transmission](#)

[Back](#)

## Druid Technology

---

Please enable BOOST in Device Setting on data center or App.

After that, please do setting delivery again. If the device is deployed, please wait for the next successful transmission for the settings to be applied.

[Back](#)



## Druid Technology

---

Please enable BOOST in Device Setting on data center or App.

After that, please do setting delivery again. If the device is deployed, please try to get as close to the animal as you can, or use a HUB or QUEST as a mobile relay, to do setting delivery again.

[Back](#)

## Druid Technology

---

Select your device type.

- [Device with cellular network transmission](#)
- [Device with INTELINK transmission](#)

[Back](#)

## Druid Technology

---

The reason is that setting delivery is not done when device is turned on.

Please do setting delivery again. If the device is deployed, please wait for the next successful transmission for the settings to be applied.

[Back](#)

## Druid Technology

---

The reason is that setting delivery is not done when device is turned on.

Please do setting delivery again. If the device is deployed, please try to get as close to the animal as you can, or use a HUB or QUEST as a mobile relay, to do setting delivery again.

[Back](#)

## Druid Technology

---

Possible reasons are:

- [Battery level is low \(grey, red or yellow battery icon\)](#)
- [BOOST setting not applied](#)

[Back](#)

## Druid Technology

---

Possible reasons are:

- [Battery level is low \(grey, red or yellow battery icon\)](#)
- [BOOST setting not applied](#)

[Back](#)

## Druid Technology

---

The reason could be not delivering setting to the device after turning on the device, either by App or magnet.

For a cellular device, please wait for the next transmission session for BOOST setting to be applied.

For an INTELINK device, please [deliver setting](#) to the device.

[Back](#)

## Druid Technology

---

The reason could be not delivering setting to the device after turning on the device, either by App or magnet.

For a cellular device, please wait for the next transmission session for BOOST setting to be applied.

For an INTELINK device, please [deliver setting](#) to the device.

[Back](#)



## Continuing low battery

Battery icon is continuously grey, red or yellow. Below are the possible reasons.

- [Low light intensity](#)
- [Normal light intensity but solar panel fully or partially covered](#)
- [Improper device setting](#)
- [High battery consumption by GNSS](#)

[Back](#)

## Error or crash of Ecotopia App or Ecotopia data center

- Ecotopia App

Please update the App to the latest version and try again. If it doesn't work, please go to About us > Local log to [upload all local logs](#) and contact us.

- Ecotopia data center

Please clear the cache of the browser, restart the browser and try again.

[Back](#)

## Data loss

Before you start, make sure that the [data subscription status](#) is set to Active and [ODBA is subscribed](#).

Choose one of the following symptoms.

- [Latest section of data lost](#)
- [Old section of data lost](#)
- [Certain types of scheduled data lost](#)
- [Data lost on 2D track under Month or Year mode](#)
- [BOOST data lost](#)

[Back](#)

## Data loss

Before you start, make sure that the [data subscription status](#) is set to Active and [ODBA is subscribed](#).

Choose one of the following symptoms.

- [Latest section of data lost](#)
- [Old section of data lost](#)
- [Certain types of data lost](#)
- [Data lost on 2D track under Month or Year mode](#)
- [BOOST data lost](#)

[Back](#)

## Druid Technology

---

Please go to Device Setting on data center or App to check if BOOST feature is enabled.

[-BOOST is enabled](#) [-BOOST is not enabled](#)

[Back](#)

## Druid Technology

---

Possible cause:

In case of a large amount of stored data, the device cannot transmit all the data in one transmission session. The data transmission priority is GNSS data > Environment Data > ODBA. So that's why you may see complete GNSS data while the latest ENV Data and ODBA is "lost".

**Solution:** You don't need to take any actions. The rest data will be transmitted in the following transmission sessions until all the data is transmitted.

[Back](#)

## Druid Technology

---

Possible causes are:

- [Abruption during last transmission due to weak network](#)
- [Battery level is low \(grey, red or yellow battery icon\)](#)

[Back](#)

## Druid Technology

---

Possible cause:

Battery level is lower than the data collection threshold during that period.

[Back](#)



## Druid Technology

---

Click [here](#) to see possible reasons and solution.

[Back](#)

### Device is turned on

**Solution:** Avoid interferences like magnetic field and electric field, place the device closer to mobile phone and try a few more times. If it still fails, please [upload local logs](#) and contact us.

[Back](#)

# Troubleshooting

Choose the problem you want to solve and follow the diagnosis procedure to proceed. If the problem still exists, please contact [support@druid.tech](mailto:support@druid.tech) for help.

- [Data not updated](#)
- [Data inconsistent with setting](#)
- ["-" mark appears among GNSS data](#)
- [Continuing low battery](#)
- [Devices not found by Ecotopia App via INTELINK](#)
- [Error or crash of Ecotopia App or Ecotopia data center](#)

### **Solar panel covered by animal's feather or fur**

The animal's feather or fur might only cover the solar panel not the light sensor. So you might still see a curve that indicates high light intensity while the solar panel cannot be exposed to sunlight. Please take animal's molting and its habitat environment into consideration during the deployment.

[Back](#)

## Druid Technology

---

The device is located somewhere with GNSS signal interference or blocking like water surface or dense woods, under a roof or in a cave.

**Solution:** Please move the device to an open space with favorable environment and try again. If it is already deployed, please wait for the animal to move to a different place.

[Back](#)

## "-" mark appears among GNSS data

When GNSS positioning fails, you will see a "-" mark. Below are two possible reasons.

- [GNSS signal interference or blocking](#)
- [GNSS antenna malfunction or broken](#)

[Back](#)

## Data inconsistent with setting

Before you start, make sure that [data subscription status](#) is set to Active and [ODBA is subscribed](#).

Choose one of the following symptoms.

- [More data than setting](#)
- [Less data on a track map](#)
- [No BOOST data updated](#)
- [No update of an old section of data](#)

[Back](#)

### **No data synchronization for an INTELINK device**

**Solution:** The device is an INTELINK device that needs a gateway (a gateway device like DEBUT HUB or a mobile phone with Ecotopia App installed) to perform [data synchronization](#).

[Back](#)



### **No data synchronization for an INTELINK device**

**Solution:** The device is an INTELINK device that needs a gateway (a gateway device like DEBUT HUB or a mobile phone with Ecotopia App installed) to perform [data synchronization](#).

[Back](#)

## Devices not found by Ecotopia App via INTELINK

Make sure that Ecotopia App is updated to the latest version and Bluetooth is authorized to Ecotopia App before you proceed.

Choose one of the following symptoms.

- [LED is not blinking after you shake the device](#)
- [LED is blinking after you shake the device](#)
- [The device doesn't have a LED](#)

[Back](#)

## Druid Technology

---

The device is already turned on, but the INTELINK connection is influenced by magnetic field or electric field, etc.

**Solution:** Please avoid interferences, place the device closer to mobile phone and try a few more times. If it still fails, please go to About us > Local log to [upload all local logs](#) and contact us.

[Back](#)

## Druid Technology

---

Overall light intensity is lower especially during winter seasons. Please [set the device properly](#) to achieve energy balance.

[Back](#)

## Druid Technology

---

The bird's feather might cover the solar panel while not covering light sensor. So, you might still see normal or high light intensity while actually the solar panel can't be charged. Please take bird's molting and its body movement into consideration when deploying a bird.

[Back](#)

# Uploading local log

## Android device

1. Tap **User > About Ecotopia > Log**.
2. Tap **Local log**.
3. Check the log size.

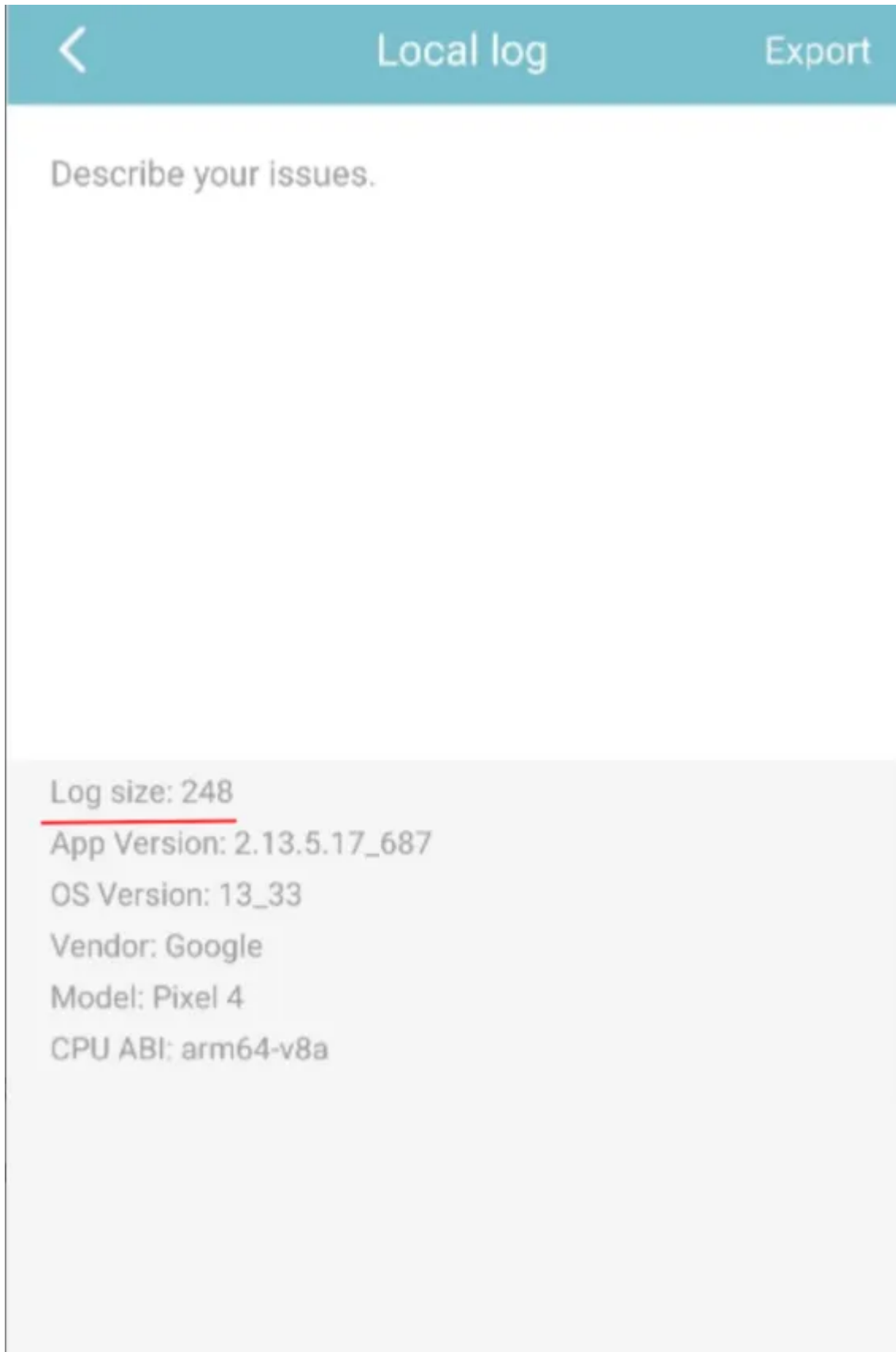

- If it is less than 10,000, tap **Submit** and wait for the app to upload the local log.
- If it is over 10,000, tap **Export** to save the log to your phone storage, then send it to us via IntelinkGO or email.

### iOS device

1. Tap **User > About Ecotopia > Local log**.

2. Tap **Upload**.

When the upload options appear, tap **Mail** to email the local log to us, or save it to your phone storage and send it via IntelinkGO.



### Low battery

**Solution:** Please charge the device under direct sunlight for 1 ~ 2 days and then try again. For more info on battery charging, please refer to the Battery section of [FAQ](#).

[Back](#)

## Druid Technology

---

Possible cause:

BOOST is enabled. Click [here](#) to know more.

[Back](#)

## Druid Technology

---

Possible reasons are:

- [The device wasn't turned on \(or accidentally turned off\).](#)
- [No cellular network for a cellular device](#)
- [No data synchronization for an INTELINK device](#)

[Back](#)

## Druid Technology

---

Some models don't have a LED and their Intelink will broadcast on a regular basis. In this case, please search and wait for several minutes. If it still fails, below are possible reasons:

- [Low battery](#)
- [Signal interference](#)

[Back](#)

### **No cellular network for a cellular device**

**Possible reason:** The device is located somewhere with no cellular network or with strong magnetic or electric interference like metal surface and magnet surface or near a transformer, etc.

**Solution:** Move the device somewhere with cellular network and place it far away from any possible interference and try again. If the device is deployed, please wait for the animal to move somewhere with network connection. Based on experience, the waiting could be up to months.

[Back](#)

### **No cellular network for a cellular device**

**Possible reason:** The device is located somewhere with no cellular network or with strong magnetic or electric interference like metal surface and magnet surface or near a transformer, etc.

**Solution:** Move the device somewhere with cellular network and place it far away from any possible interference and try again. If the device is deployed, please wait for the animal to move somewhere with network connection. Based on experience, the waiting could be up to months.

[Back](#)

## Druid Technology

---

In case of a large amount of stored data, the device cannot transmit all data in one transmission session. As data transmission priority is GNSS data > Environment Data > ODBA, you may see all GNSS data updated while the latest section of ENV Data and ODBA is not updated.

**Solution:** Please wait for the rest data to be transmitted in the following transmission sessions.

[Back](#)

## Druid Technology

---

The device is improperly set, e.g., too frequent data collection or transmission. Please set the device properly to achieve energy balance. Click [here](#) to know more.

[Back](#)



## Druid Technology

---

Possible reasons are:

- [Battery level is low \(grey, red or yellow battery icon\)](#)
- [No cellular network for a cellular device](#)
- [No data synchronization for an INTELINK device](#)

[Back](#)

## Data not updated

Before you start, make sure that [data subscription status](#) is set to Active and [ODBA is subscribed](#).

Choose one of the following symptoms.

- [All data types never updated](#)
- [All data types updated and then stopped updating](#)
- [Part of the data types updated](#)
- [No BOOST data updated](#)

[Back](#)

### **The device wasn't turned on (or accidentally turned off)**

**Solution:** If you are testing the device, please turn it on and then try again. If the device has already been deployed, please contact us to enable [7-day waking up](#) for the device.

[Back](#)

## How long should I charge a device?

Under direct sunlight, a terminal device can be fully charged for several hours or several days depending on the weather. Note that the device should be placed on some insulation material to avoid extreme heat during charging.

With a cable, a HUB can be fully charged for around 8 hours and a QUEST can be fully charged for around 2 hours.

## **When I deploy my device to another animal, is the previous data in the device removed?**

If you plan to deploy your device to another animal, please contact us to help you hide all the data before a certain date. We recommend that you purchase our Rebewal plan so that you can get a new device.

## Edge Intelligence setting template for hourly data collection

When you wish to gather specific data at hourly intervals, you can establish the configuration using this template. The provided template pertains to the hourly collection of GNSS data, but should you desire to acquire different data types at an hourly frequency, you can adjust the data type accordingly.

For instance, consider the scenario where you need to collect GNSS data at 6 AM daily and obtain a GNSS data point each hour between 2 PM and 8 PM. There are two methods to achieve this using Edge Intelligence.

### Method A

Basic Setting: GNSS is deactivated. The configuration of other data should align with research requirements. It is advisable to maintain one-hour intervals for environmental data and ten-minute intervals for ODBA. Following these recommended frequencies, the collection and transmission of environmental and ODBA data will not significantly impact the tracker's battery life or storage capacity.

### Edge Intelligence Setting:

Rules	Condition			Action	
Rule 1	and/or	Enter from 5:30 to 6:30 daily		GNSS interval: 1 hour	
Rule 2	and/or	Enter from 13:30 to 20:30 daily		GNSS interval: 1 hour	

### Example of Rule 1:

Condition [View help](#)

Condition relation  
 and  or

Variety <sup>?</sup> Time range <input type="text"/>	Trigger In <input type="text"/>	Timezone <sup>?</sup> UTC+0 <input type="text"/>	Time type Every day <input type="text"/>	Every day <sup>?</sup> 05:30:00 → 06:30:00 <input type="text"/> 1h 0m 0s
---	------------------------------------	---	---	---

Action [View help](#)

Activate after <sup>?</sup>  
Once immediately  s

Setting item <sup>?</sup> GNSS collecting <input type="text"/>	Mode <sup>?</sup> Interval <input type="text"/>	Interval <sup>?</sup> 3600 <input type="text"/> s	Duration <sup>?</sup> Continuously <input type="text"/> s	Expected collecting time (Timezone UTC+0) 2023-10-21 04:00:00 <input type="text"/>
---	--	--	--	--

Example of Rule 2:

Condition [View help](#)

Condition relation  
 and  or

Variety <sup>?</sup> Time range <input type="text"/>	Trigger In <input type="text"/>	Timezone <sup>?</sup> UTC+0 <input type="text"/>	Time type Every day <input type="text"/>	Every day <sup>?</sup> 13:30:00 → 20:30:00 <input type="text"/> 7h 0m 0s
---	------------------------------------	---	---	---

Action [View help](#)

Activate after <sup>?</sup>  
Once immediately  s

Setting item <sup>?</sup> GNSS collecting <input type="text"/>	Mode <sup>?</sup> Interval <input type="text"/>	Interval <sup>?</sup> 3600 <input type="text"/> s	Duration <sup>?</sup> Continuously <input type="text"/> s	Expected collecting time (Timezone UTC+0) 2023-10-21 04:00:00 <input type="text"/>
---	--	--	--	--

Method B

Basic Setting: GNSS data interval 1 hour, environmental data interval 1 hour, ODBA interval 10 minutes.

Edge Intelligence Setting:

Rules	Condition			Action	
Rule 1	and/or	Enter from 20:30 to 5:30 daily		GNSS off	
Rule 2	and/or	Enter from 6:30 to 13:30 daily		GNSS off	

### Example of Rule 1:

Condition [View help](#)

---

Condition relation  
 and  or

---

Variety <a href="#">?</a> Time range <input type="text"/>	Trigger In <input type="text"/>	Timezone <a href="#">?</a> UTC+0 <input type="text"/>	Time type Every day <input type="text"/>	Every day <a href="#">?</a> 20:30:00 → 05:30:00 <sup>+1</sup> <input type="text"/> 9h 0m 0s
--	------------------------------------	--	---	--

[+](#) Add

---

Action [View help](#)

---

Activate after <a href="#">?</a> Once immediately <input type="text"/> s	Setting item <a href="#">?</a> GNSS collecting <input type="text"/>	Mode <a href="#">?</a> Off <input type="text"/>
---	--	--

[+](#) Add

### Example of Rule 2:

Condition [View help](#)

---

Condition relation  
 and  or

---

Variety <a href="#">?</a> Time range <input type="text"/>	Trigger In <input type="text"/>	Timezone <a href="#">?</a> UTC+0 <input type="text"/>	Time type Every day <input type="text"/>	Every day <a href="#">?</a> 06:30:00 → 13:30:00 <input type="text"/> 7h 0m 0s
--	------------------------------------	--	---	--

[+](#) Add

---

Action [View help](#)

---

Activate after <a href="#">?</a> Once immediately <input type="text"/> s	Setting item <a href="#">?</a> GNSS collecting <input type="text"/>	Mode <a href="#">?</a> Off <input type="text"/>
---	--	--

[+](#) Add





## FAQ

FAQ (Frequently Asked Questions) contains the following topics.

---

### Account

- [How can I retrieve account password?](#)
  - [Why is my QUEST not under my account?](#)
- 

### data subscription status

- [Why are my newly received devices Suspended? How can I change it?](#)
  - [Why is there an alarm icon indicating "Abnormal" for a device?](#)
  - [Why is my QUEST not under my account?](#)
- 

### Maintenance

- [How should a device be maintained if it will not be used anytime soon?](#)
- 

### Battery and Charging

- [How to charge X-Filming/Coating devices?](#)
- [How can I determine if the battery is charging OK?](#)
- [What are the working voltage thresholds for DEBUT devices?](#)
- [How to wake up a "sleeping" battery](#)

- [How long does it take to charge the device battery?](#)
  - [How to charge the device manually when the weather condition is not good?](#)
  - [How long is the battery life of DEBUT devices? How many GNSS fixes can it collect?](#)
  - [What's the lifespan of a device \(battery\)?](#)
  - [Why the battery of a device is continuously at a low level?](#)
- 

## Turning On a Device

- [Does it mean the device is turned on when the status is set to Active?](#)
  - [Can a device be turned on if App is not connected to internet?](#)
  - [How to check if a device is turned on?](#)
  - [Will my DEBUT device be turned off when the battery level is low?](#)
  - [What should I do if I forgot to turn on a deployed device?](#)
  - [Why are devices not found by Ecotopia App via INTELINK?](#)
- 

## Setting

- [Why too short working intervals should be avoided?](#)
  - [Why are the data intervals not consistent with my setting?](#)
  - [How to properly manage the setting of a device?](#)
  - [When does the changed setting take effect?](#)
  - [What is BOOST and how to set it?](#)
- 

## Edge Intelligence

- [Edge Intelligence Instruction](#)
- [Edge Intelligence Setting template for Geo-fence](#)
- [Edge Intelligence Setting Template for Time Schedule](#)
- [Edge Intelligence Setting Template for Flight Period](#)

---

## Data Updating

- [Why is the data not updated?](#)
- [Why are the data intervals not consistent with my setting?](#)
- [Will data stop updating if my billing account is overdue?](#)

---

## Status Bar Icon

- [What do different colors of device number and icons mean?](#)

---

## Data Downloading

- [Why error occurs during data downloading?](#)
- [Why is the download link blank or missing after the download is complete?](#)
- [What is the meaning of each field in the downloaded CSV data?](#)

---

## GNSS Data

- [Why is there repetitive GNSS data and minor time deviation for Argos devices?](#)
- [Why is GNSS data sometimes blank?](#)
- [Why does one obvious GNSS error occurs sometimes?](#)
- [What's the GNSS accuracy of DEBUT devices?](#)

---

## Algorithm Data

- [What is ODBA?](#)
- [How to obtain acceleration raw data? Can I set the collecting interval?](#)
- [How can I know the direction of X/Y/Z axis of ACC data as represented on a device?](#)
- [Is the data downloaded from data center preprocessed?](#)

---

## Event Data

- [What is Beacon data and Proximity data?](#)
- 

## Argos

- [Why is there repetitive GNSS data and minor time deviation for Argos devices?](#)
  - [What does a user need to do before using an Argos device from Druid?](#)
  - [How does Druid's Argos-GPS device work?](#)
  - [Why are there discrepancies between location data on the Argos platform and Ecotopia platform?](#)
- 

## Data Platform

- [Which time zone is used in data center and App?](#)
  - [What are Device number, UUID and Device ID?](#)
  - [What do different colors of device number and icons mean?](#)
  - [Why is the last GNSS fix of a track for a day different from that for a month or a year?](#)
  - [Why some GNSS fixes of a track are missing under Month and Year mode?](#)
- 

## Deployment

- [What are the recommended adhesives for deployment](#)
- [Can the collar be removed from the main part after sliding in and locked?](#)
- [What's the impact to DEBUT devices if the operator shuts down its 2G or 3G network?](#)
- [Can I choose a specific telecom operator for my DEBUT devices?](#)
- [How to confirm an animal death or device fall?](#)
- [How to activate Debut Renewal Plan?](#)
- [Can data collected before deployment be hidden?](#)

---

## Gateway

- [How to use other users' HUB to collect data from your device?](#)
- [Is it possible to enlarge the INTELINK/LoRa range of a HUB?](#)
- [What are terminal devices and gateway devices?](#)
- [How to use gateway devices as a mobile relay?](#)
- [How does HUB work?](#)
- [What's the range of INTELINK?](#)
- [Why is my QUEST not under my account?](#)

## Why is the latest section of data “lost”?

The latest section of data may be “lost” because the latest section of data fails to be transmitted to the cloud server due to poor transmission signal or low battery. In either case, the collected data will be stored in the device memory and will be transmitted when the device is connected to the transmission network again or after power recovery.

**Note:** The transmission can mean cellular network, Argos, Lora or INTELINK for different models.

For each transmission session, the device will first transmit a newly collected data, then transmit the remaining data in the order of collecting time (older data transmitted first).

In case of a large amount of stored data, the device cannot transmit all the data in one transmission session and will continue transmitting the remaining data in the following transmission sessions until all the data is transmitted. The data transmission priority is GNSS data > Environment Data > ODBA. So sometimes you may see complete GNSS data while the latest section of Environment Data and ODBA is “lost”.

Under default setting, Debut devices can store up to 460 days of data and thus you don't need to worry about full device memory and data loss.

## Why are the data intervals not consistent with my setting?

When [BOOST](#) is triggered, it automatically regulates the GNSS and other data collecting intervals, so as to utilize the energy better and contribute more to the movement research.

With the [BOOST](#) feature, the device intelligently enhance data frequency on the basis of energy balance without manual interference. You can choose to switch on/off the [BOOST](#) feature, and you can also export data with or without the part from dynamic collecting and in-flight collecting.



## How to generate GNSS track for multiple devices?

You can view GNSS track of multiple devices on the same map in Ecotopia data center. For more information, see [Generating multiple GNSS tracks on the same map](#).



## Device Collaboration

Device collaboration feature allows you to share your device to a group so that members in the group can view or download various data from the device. You can also view or download various data from a device that shared by other members in the group. The following permissions determine what data a group member can view or download.

- **Group permission**  
Group permission is set by the group admin. All members and devices added to this group will follow the same group permissions if no individual permissions are applied.
- **Member permission**  
When adding a new member, the group admin can set a different permission for the member. The added member will follow his own member permission instead of the group permission.
- **Device permission**  
When adding a device, the device owner can set a different permission for the device. The added device will follow its own member permission instead of the group permission.
- **Account permission**  
The account permission of a user is set by the organization administrator when adding new sub-account.

The final permission that a member can have is the intersection of the **group permission** set by the group owner (if a member permission is set for the member, this member will follow his own member permission instead of the group permission ), the **member permission** set by the group owner (if not set, the group permission is applied), the **device permission** set by the device owner (if not set, the group permission is applied) and the **account permission** set by the organization administrator of the device owner.

Click the links below to view the relevant content.

- [Creating Group](#)
- [Adding Member](#)
- [Adding Device](#)
- [Sharing Group](#)



## Comparing Different Tracks

Before you start, make sure that you have generated a static track.

1. On the static track page, set the comparison item.

On this page, you can see a control panel as below:

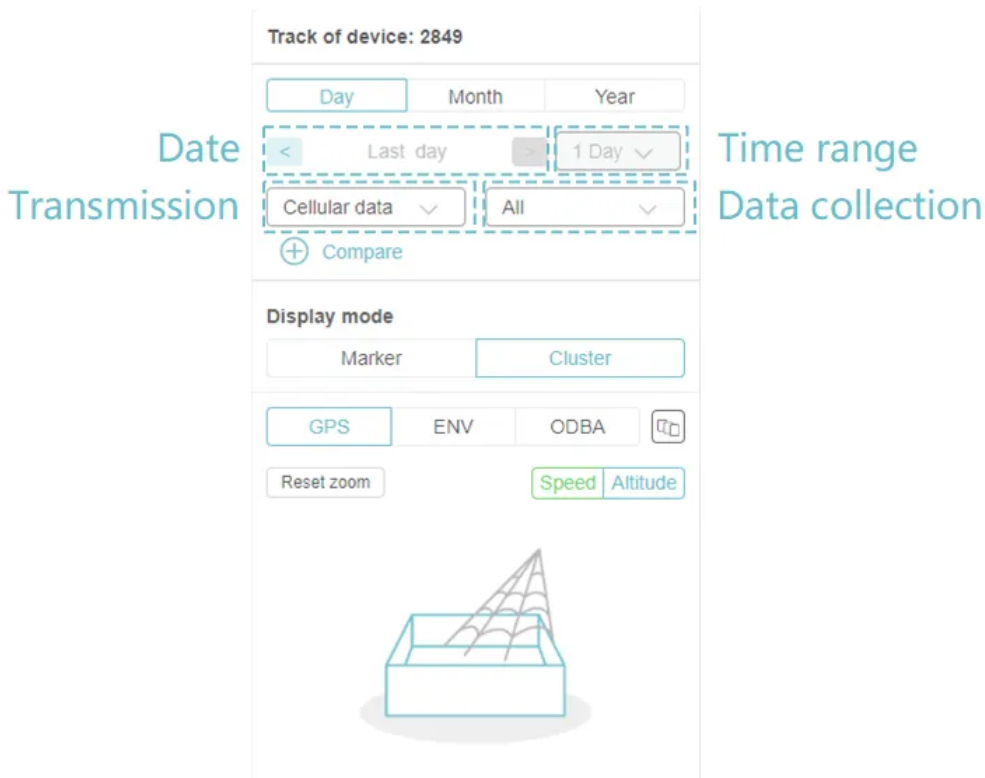

Set the comparison item as needed.

- **Date**  
Generate the track on a specific date
- **Time range**  
Generate the track in a specific time range, from 1 day to 7 days.
- **Transmission**  
Generate the track by different transmission methods, including cellular, Argos, BeiDou, SMS and Base station positioning. This option is not available when the time range is greater than 1 day.
- **Data collection**  
Generate the track by different data collection methods, including Scheduled, Dynamic and Flight. This option is **not** available when the time range is greater than 1 day or when the transmission method is **not** cellular.

## 2. Add comparison item.

When you finish setting the comparison item, click  icon to add it. After you add the comparison item, a window pops out on the left of the control panel.

## 3. Click the comparison item on the left window, data center displays the relevant track in different color.

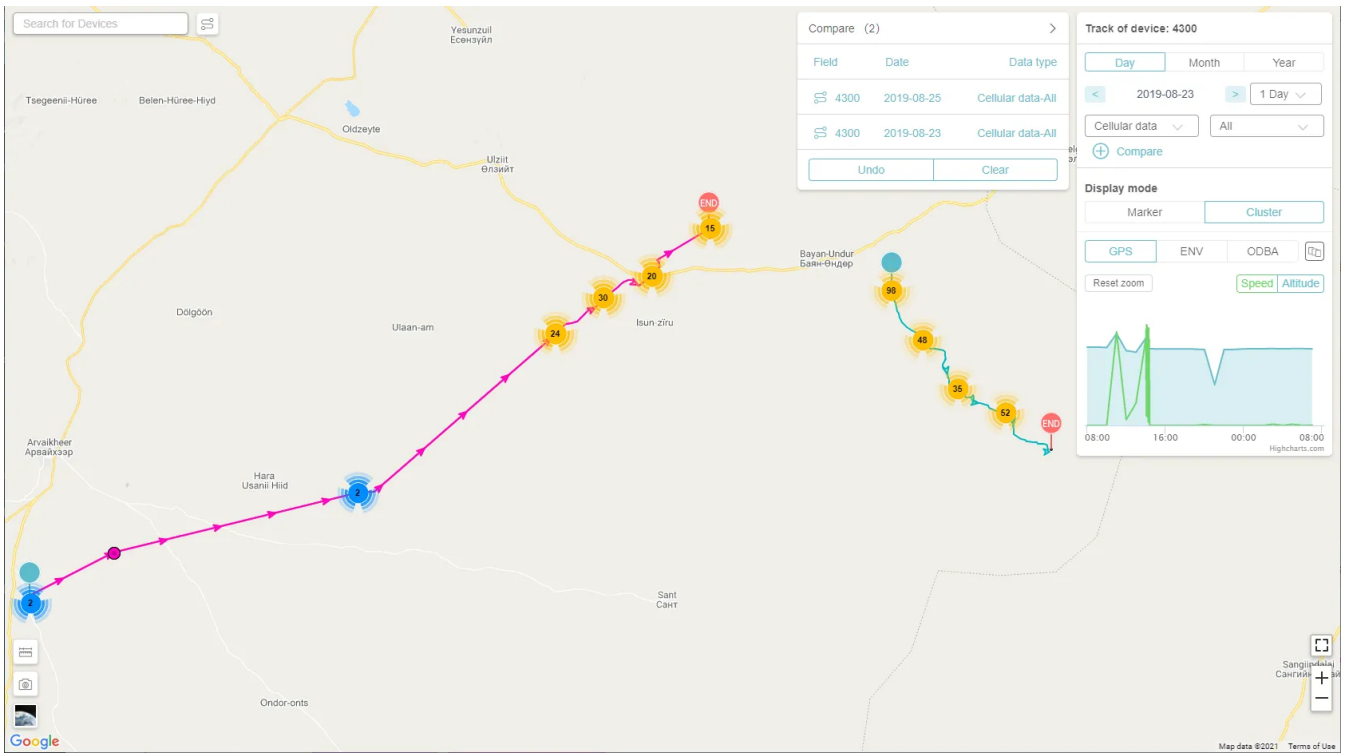

## Multiple Accounts Support

Ecotopia data center supports multi-account collaboration. You can create multiple sub-accounts, assign devices to each sub-account, and assign different operation permissions.

- [Creating Account](#)
- [Assigning Device](#)
- [Permission Management](#)
- [Removing Device](#)

# Device Finding

Follow below steps to find a device. Before you start, make sure that the Bluetooth is enabled on your phone and authorized to Ecotopia App. Make sure that your mobile is not muted.

Step 1:

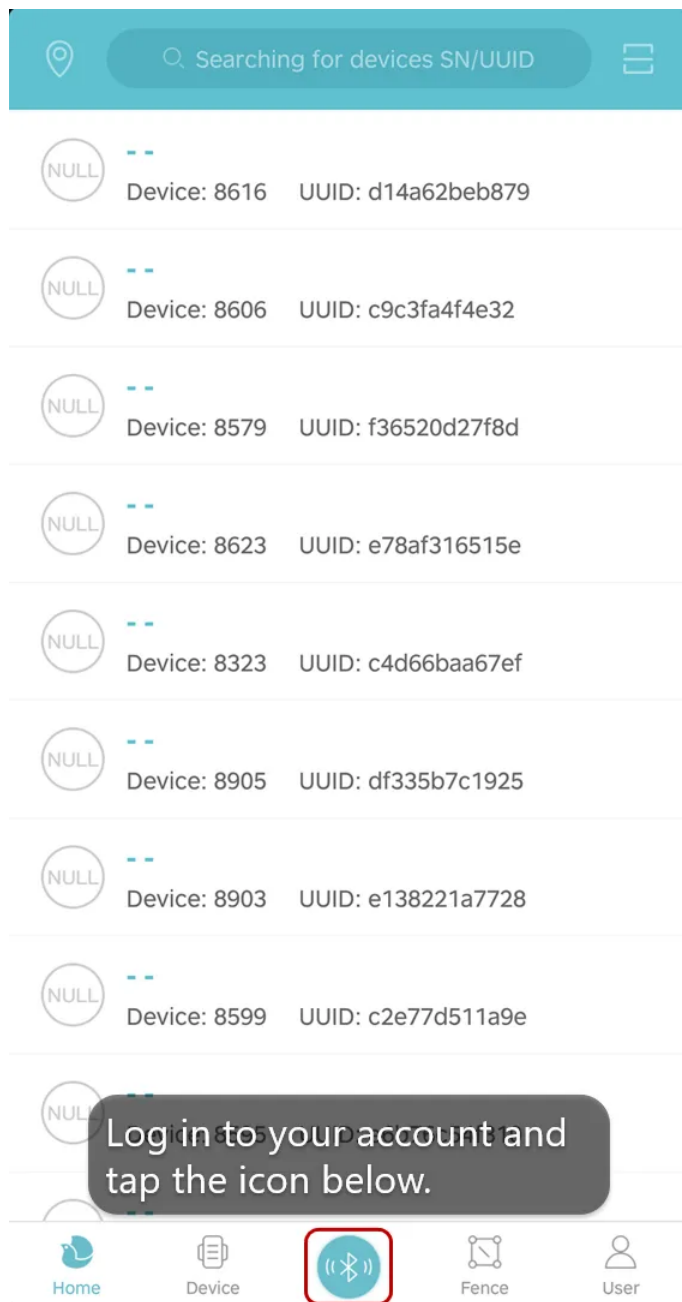

Step 2:





Step 3:

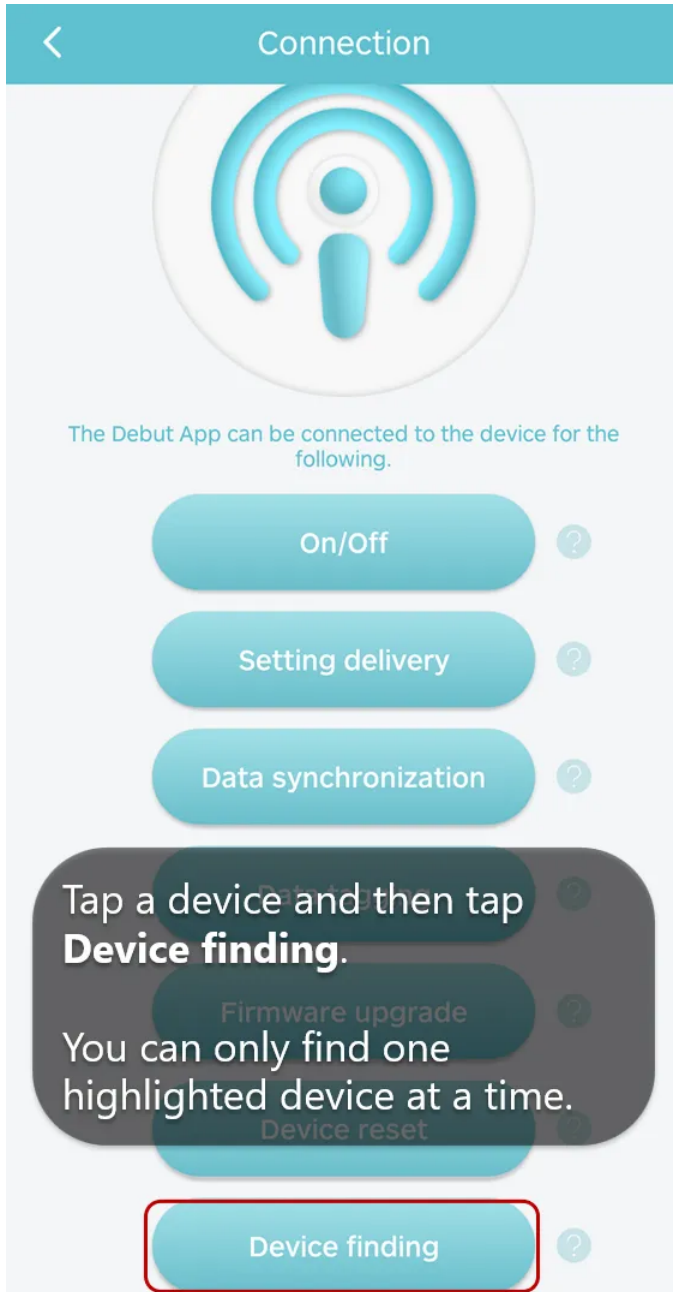

Step 4:



## Animal finding

2021-12-20 19:27:26  
RSSI: -81

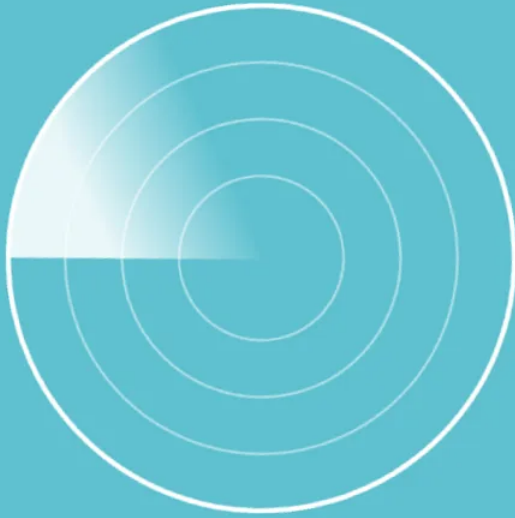

Stop

\*The louder, the closer

The mobile starts ringing. The closer you are to the device, the stronger the ringtone. Find the device according to the strength of the ringtone.

# What's new

- Device collaboration

You can share your device to a group so that members in the group can view or download the device data. You can also view or download data of the devices shared by other members.

See [Device collaboration](#) for more information.

- Platform and Account

You can manage your platform and account with Ecotopia App. See [Platform and account](#) for more information.

- INTELINK

INTELINK page can display terminal, gateway and QUEST in separate tab. Now you can select a gateway/QUEST and connect to a terminal device within range through it.

- Permission management

Now you can set Edit or View permission for different data types for all sub-accounts.

## Quick Start

Click the links below to view the Quick Start guide.

- [DEBUT Series Quick Start \(Cellular\)](#)  
Applicable for cellular (2G/3G/4G/5G) transmission models like FLEX II 3G, MINI 5G, LEGO 4G, etc.
- [DEBUT Series Quick Start \(Satellite\)](#)  
Applicable for satellite (Beidou/Argos/Iridium/Globalstar) transmission models like MINI Argos, BADGE Iridium, etc.
- [DEBUT Series Quick Start \(HUB\)](#)  
Applicable for DEBUT HUB.
- [DEBUT Series Quick Start \(Intelink\)](#)  
Applicable for INTELINK transmission models like NANO, ULTRA P1, etc.

## Android Version History

### v 2.13.5.19

Added Argos R3 device

### v 2.13.5.9.8

- Added image data list
- Added image data detail
- Added image download

### v 2.13.5.9.2

Added global star data type

### v 2.13.5.4

- Optimized INTELINK operation interface
- Added firmware upgrade for multiple devices

### v 2.13.5.0

Added beacon positioning data

### v 2.13.4.9

ODBA collecting interval can be set to 1 minute

### v 2.13.0.3

Track can now be generated with INTELINK summary data

### v 2.12.9.11

Terminal, gateway and QUEST are now categorized on INTELINK page

### v 2.12.9.10

Added permission management

#### v 2.12.9.6

Added Terms of Use

#### v 2.12.6

- Adding platform by QR code is supported
- BOOST setting is supported
- Heatmap is added to the map page
- INTELINK optimization

#### v 2.9.0

- DEBUT App is officially renamed to Ecotopia App
- Added Quest and Animal sharing. The quest and animal sharing are published to a whole new app, Intelink. You can download it at Google Play.

#### v 2.8.3.18

Added cache management feature

#### v 2.8.3.15

- Added device reset feature
- Optimized device turning on process

#### v 2.8.3.9

- INTELINK page is displayed after tapping the scan icon
- INTELINK page is displayed after tapping **Nearby devices**
- Optimized the style of multiple choice on INTELINK page
- Time displayed on all pages will follow the time zone set by the user

#### v 2.8.3.3

- Added firmware upgrade feature
- Added firmware management feature
- Device list will display data subscription status

#### **v 2.8.2.20**

- Added ODBA subscription and status switch feature
- Added customization for label color
- Added device archive feature
- Maximum number of label is increased to 5

#### **v 2.8.2.18**

Optimized INTELINK feature for different types of devices

#### **v 2.8.2.13**

- Added Argos data and Beidou data
- Now you can generate track using Argos data and Beidou data

#### **v 2.8.2.4**

- Added acceleration raw data and base station data
- Optimized data list and data chart
- Added device information to animal information page

#### **v 2.8.1.37**

- Added mammal as a new animal category
- Added animal photo uploading feature



## Ecotopia App version history

- [Android Version History](#)
- [iOS Version History](#)

## iOS Version History

### v 2.11.40

Added Argos R3 device

### v 2.11.27

- Added image data list
- Added image data detail
- Added image download

### v 2.10.18

Added data tagging result edit feature

### v 2.10.7

Track can now be generated with INTELINK summary data

### v 2.9.2

Optimized user interface

### v 2.8.8

Added permission management

### v 2.8.6

Added relay device to the device list

### v 2.8.5

Terminal, gateway and QUEST are now categorized on INTELINK page

### v 2.8.3

Added Terms of Use

## **v 2.8.1**

Added BOOST settings

## **v 2.8**

- improved INTELINK scanning speed
- New Device ID is supported

## **v 2.7.4**

- Added platform customization
- Fixed known bugs

## **v 2.7.0**

- DEBUT App is officially renamed to Ecotopia App
- Added Quest and Animal sharing. The quest and animal sharing are published to a whole new app, Intelink. You can download it at App Store.

## **v 2.6.0**

Added cache management feature

## **v 2.5.7**

- Added device reset feature
- Optimized device turning on process

## **v 2.5.3**

Optimized time zone display

## **v 2.5.1**

- Optimized for iOS 15
- Improved firmware upgrading speed

## **v 2.5**

Added firmware management feature

## **v 2.4.9**

- Added firmware upgrade feature
- Optimized INTELINK operation history

#### **v 2.4.8**

Added on-screen instructions to INTELINK page

#### **v 2.4.5**

- Scanned device will be highlighted on INTELINK page
- Added **Nearby devices** and **Operation history** to INTELINK page
- Track is added to the map

#### **v 2.4.2**

Added Argos data and Beidou data

#### **v 2.4**

Added INTELINK feature

#### **v 2.3.7**

- Optimized animal information page
- Optimized detailed animal information page
- Added mammal as a new animal category

## Version history

You can view the version history of Ecotopia data center and Ecotopia app.

- [Ecotopia Data Center Version History](#)
- [Ecotopia App Version History](#)

# Ecotopia Data Center Version History

## 2024.05.06

Added Argos R3 device

## 2024.03.01

Added VHF device

## 2023.10.19

- Beacon and Manual geotagging is added to location data
- Beacon raw data is added to event data

## 2023.10.16

Added Spanish and French language support

## 2023.09.26

Added GNSS high frequency sampling feature

## 2023.09.07

Added Japanese language support

## 2023.05.08

Combined schedule is added to device setting mode

## 2022.10.09

Added GPS data type to customizaed data downloading

## 2022.09.23

- Added edge intelligence setting
- Optimized on-page help information

## **2022.09.19**

Added data chart for Argos, Iridium and Beidou summary data

## **2022.08.09**

Optimized data exporting

## **2022.08.01**

- Added permission setting for sub-accounts
- Added Relay device list

## **2022.06.14**

Added BOOST setting feature

## **2022.04.20**

Optimized device ID display

## **2022.03.30**

Korean language is now supported

## **2022.01.10**

Now you can change data subscription status of multiple devices at a time

## **2021.12.27**

Now you can delete one or more GNSS fixes from a static track

## **2021.12.23**

Added preferences setting

## **2021.10.26**

Archived device will display insurance icon

## **2021.10.18**

- Added event data. You can download the event data or view it on device information page

- Optimized device list

### **2021.10.13**

- Time displayed on every page will follow the time zone set by the user
- Time zone is displayed on the top bar
- When you add device to your child account, you can upload a file to filter the device

### **2021.09.14**

- An on-screen window is added to show the progress during the data downloading
- data subscription status is added to the device list

### **2021.08.27**

- Now you can download Argos data and Beidou data
- Optimized the layout on data downloading page
- Optimized the pagination

### **2021.08.20**

- Added data subscription status feature
- Added ODBA subscription

### **2021.08.18**

You can choose to show or hide GNSS fixes on 2D track page

### **2021.07.29**

- Added customization for label color
- Maximum number of label is increased to 5

### **2021.07.21**

- 2D track displays the data of the last day by default
- In year / month mode, 2D track displays the data of the month and year when the last data is collected
- GNSS fix option and current location is moved to the lower left of the map

### **2021.06.17**



- Advanced downloading now supports merge feature. You can download multiple data types for multiple devices
- Optimized battery icons

#### **2021.04.14**

- Argos data is divided into summary data and location data
- You can generate 2D track using Argos data

#### **2021.03.24**

Optimized 3D track display

#### **2021.03.09**

- Optimized Movebank setting
- Added delete option for settings

#### **2021.02.22**

Added map layer to 2D track page

#### **2021.02.04**

Added field explanation for data analysis page

#### **2021.01.22**

Optimized device setting page

## SwiftTips Videos

This section contains video tutorials regarding device usage and platform features. Click the link below to view related topic.

- [Device Status & Data Subscription Status](#)
- [DEBUT Renewal Plan](#)
- [Solar Charging](#)
- [IntelinkGO Instruction](#)
- [BOOST Setting](#)
- [Intuitive Map of Ecotopia](#)